



**COMHANHOLLAND**  
ALUMINIUM

FABRIC FRAMES  
FROM STOCK  
&  
CUSTOM MADE



# SEG fabric frames

SILICONE EDGE GRAPHICS FRAMES  
FOR PRINTED FABRIC







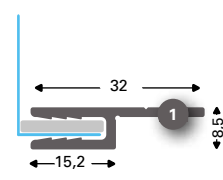

# T-Flex® Fabric frames Specifications

<b>Sign system:</b>	T-Flex® frameless fabric frames
<b>Features:</b>	Profiles & Parts for silicone edge graphics on a wall, freestanding or hanging
<b>Application:</b>	Changeable, fabric with stitched on silicone keder
<b>Use:</b>	For indoor illuminated or non-illuminated
<b>Light source:</b>	Various LED options
<b>Designed for:</b>	Single and double sided, cube and door applications
<b>Profile:</b>	6100 mm, EN AW 6060 T6, mill & anodised
<b>Parts:</b>	Feet, corner connectors, round corners, supports, support profile and quick connectors
<b>Customization:</b>	Easy-to-assemble DIY kit on request

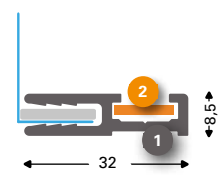

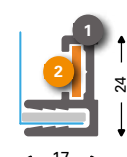
## Non-illuminated single & double sided

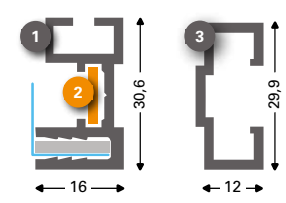
<b>T-Flex® 09 Retro</b> One-sided	 	<p>1 <b>131063*</b> T-Flex® 9/1 Adapterprofile straight anod L 6100</p>
<b>T-Flex® 17 Straight</b> One-sided	 	<p>1 <b>131002 (131004* 131003**)</b> T-Flex® 17/1 Straight mill</p> <p>2 <b>131078</b> Cornerconnector steel 17, 35 &amp; 60</p> <p>2 <b>137152</b> Cornerconnector steel 100 mm</p>
<b>T-Flex® 17 Mini</b> One-sided	 	<p>1 <b>131005 (131007* 131001** 131006***)</b> T-Flex® 17/1 Mini mill</p> <p>2 <b>137158</b> Cornerconnector M steel hexagon</p> <p>2 <b>137154</b> Cornerconnector L steel hexagon</p> <p>2 <b>137152</b> Straight connector 100 mm</p>
<b>T-Flex® 17/1 + reinforcement detail</b> One-sided	 	<p>1 <b>139130*</b> T-Flex® 17/1 with reinforcement detail anod</p> <p>2 <b>137158</b> Cornerconnector M steel hexagon</p> <p>2 <b>137154</b> Cornerconnector L steel hexagon</p> <p>2 <b>137152</b> Straight connector 100 mm</p> <p>3 <b>139132*</b> T-Flex® 17/1 Underprofile anod</p>

\* anodised profile \*\* RAL 9003 profile \*\*\* Black anodised profile

See page 18-23 for parts and accessories

**T-Flex® 32/1**  
One-sided

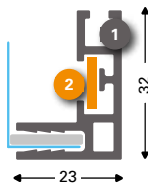

- 1 **131057 (131058\*)**  
T-Flex® 32/1 LP mill
- 2 **137158**  
Cornerconnector M steel hexagon
- 2 **137154**  
Cornerconnector L steel hexagon
- 2 **137152**  
Straight connector 100 mm

**T-Flex® 23/1**  
One-sided

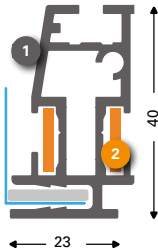

- 1 **131010 (131012\*)**  
T-Flex® 23/1 mill
- 2 **137158**  
Cornerconnector M steel hexagon
- 2 **137154**  
Cornerconnector L steel hexagon
- 2 **137152**  
Straight connector 100 mm

**SpeeTex® 25/1**  
One-sided

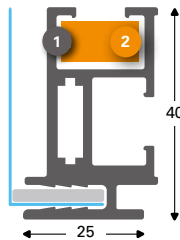

- 1 **131427**  
Speetex® 25/1 Brushed anod
- 2 **131420**  
SpeeTex® 25/1 Round corner brushed anod

**T-Flex® 30/1**  
One-sided

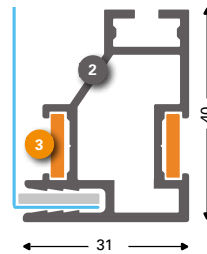
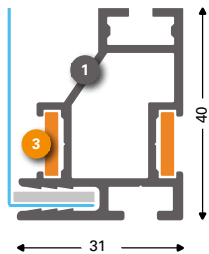

- 1 **131310 (131311\*)**  
T-Flex® 30/1 Basic mill
- 2 **131314 (131315\*)**  
T-Flex® 30/1 Basic closed mill
- 3 **137158**  
Cornerconnector M steel hexagon
- 3 **137154**  
Cornerconnector L steel hexagon
- 3 **137152**  
Straight connector 100 mm



**T-Flex® 35/1**  
One-sided

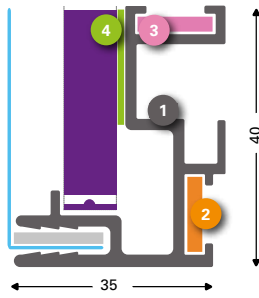

1 **131045 (131047\* 131046\*\*\*)**  
T-Flex® 35/1 LED-frame mill

- 2 **137158**  
Cornerconnector M steel hexagon
- 2 **137154**  
Cornerconnector L steel hexagon
- 3 **131078**  
Cornerconnector steel 17, 35 & 60
- 4 **3M Tape**

**T-Flex® 36/1 Bend Frame**  
One-sided

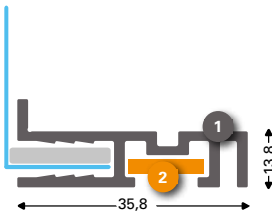

1 **131073\***  
T-Flex® Bendingprofile 36 mm anod

- 2 **137158**  
Cornerconnector M steel hexagon
- 2 **137154**  
Cornerconnector L steel hexagon
- 2 **137152**  
Straight connector 100 mm

**T-Flex® 40/2**  
One-sided

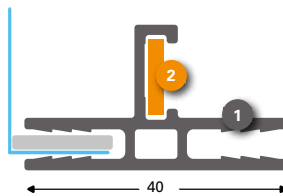

1 **131560 (131562\*)**  
T-Flex® 40/2 mill

- 2 **137158**  
Cornerconnector M steel hexagon
- 2 **137154**  
Cornerconnector L steel hexagon
- 2 **137152**  
Straight connector 100 mm
- 3 **ACP 2 mm Backpanel Matt white**  
Dimension: H-42 mm W-42 mm

**T-Flex® 40/2 LED**  
One-sided

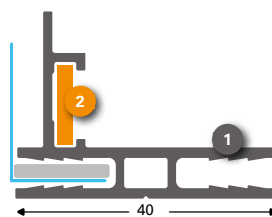

1 **131564 (131566\*)**  
T-Flex® 40/2 LED mill

- 2 **137158**  
Cornerconnector M steel hexagon
- 2 **137154**  
Cornerconnector L steel hexagon
- 2 **137152**  
Straight connector 100 mm

**T-Flex® 46/2 basic**  
Double-sided

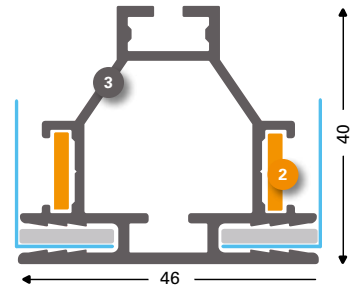
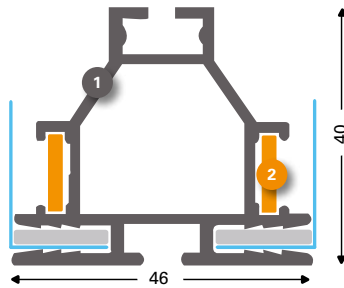

- 1 **131114 (131116\*)**  
T-Flex® 46/2 Basic open mill
- 2 **137158**  
Cornerconnector M steel hexagon
- 2 **137154**  
Cornerconnector L steel hexagon
- 2 **137152**  
Straight connector 100 mm

- 3 **131115 (131117\*)**  
T-Flex® 46/2 Basic closed mill

**T-Flex® 46/2**  
Double-sided

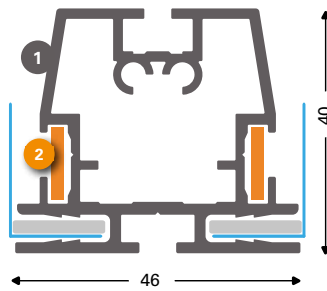







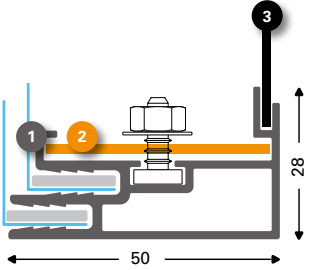

- 1 **131014 (131016\* 131015\*\*\*)**  
T-Flex® 46/2 mill
- 2 **137158**  
Cornerconnector M steel hexagon
- 2 **137154**  
Cornerconnector L steel hexagon
- 2 **137152**  
Straight connector 100 mm

See page 18-23 for parts and accessories

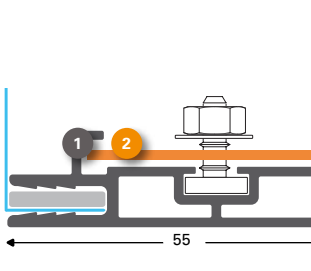

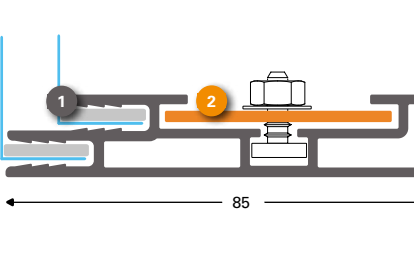

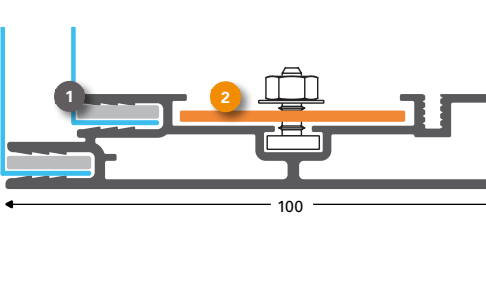
# Single-sided illuminated frames

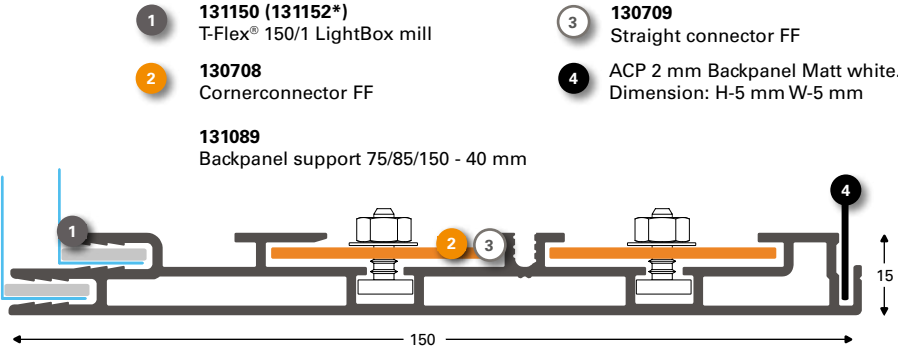
<p><b>T-Flex® 50/1</b> One-sided</p>			<ul style="list-style-type: none"> <li>1 <b>131054 (131055*)</b> T-Flex® 50/1 LightBox DT mill</li> <li>2 <b>130708</b> Cornerconnector FF</li> <li>3 <b>ACP 2 mm Backpanel Matt white</b> Dimension: H-42 mm W-42 mm</li> </ul> <p><b>131059</b> Backpanel support 50/55 - 40 mm</p>
<p><b>T-Flex® 55/1</b> One-sided</p>			<ul style="list-style-type: none"> <li>1 <b>131050 (131052*)</b> T-Flex® 55/1 LightBox mill</li> <li>2 <b>130708</b> Cornerconnector FF</li> <li>3 <b>ACP 2 mm Backpanel Matt white</b> Dimension: H-32 mm W-32 mm</li> </ul> <p><b>131059</b> Backpanel support 50/55 - 40 mm</p>
<p><b>T-Flex® 85/1</b> One-sided</p>			<ul style="list-style-type: none"> <li>1 <b>131085 (131087*)</b> T-Flex® 85/1 LightBox mill</li> <li>2 <b>130708</b> Cornerconnector FF</li> <li>3 <b>ACP 2 mm Backpanel Matt white</b> Dimension: H-5 mm W-5 mm</li> </ul> <p><b>131089</b> Backpanel support 75/85/150 - 40 mm</p>
<p><b>T-Flex® 100/1</b> One-sided</p>			<ul style="list-style-type: none"> <li>1 <b>131104(131106*131105***131107****)</b> T-Flex® 100/1 LightBox mill</li> <li>2 <b>130708</b> Cornerconnector FF</li> <li>3 <b>ACP 2 mm Backpanel Matt white</b> Dimension: H-15 mm W-15 mm</li> </ul> <p><b>131088</b> Backpanel support 100 - 40 mm</p>
<p><b>T-Flex® 150/1</b> One-sided</p>			<ul style="list-style-type: none"> <li>1 <b>131150 (131152*)</b> T-Flex® 150/1 LightBox mill</li> <li>2 <b>130708</b> Cornerconnector FF</li> <li>3 <b>130709</b> Straight connector FF</li> <li>4 <b>ACP 2 mm Backpanel Matt white.</b> Dimension: H-5 mm W-5 mm</li> </ul> <p><b>131089</b> Backpanel support 75/85/150 - 40 mm</p>

# Window system



**T-Flex® 85/2 WG**  
One-sided

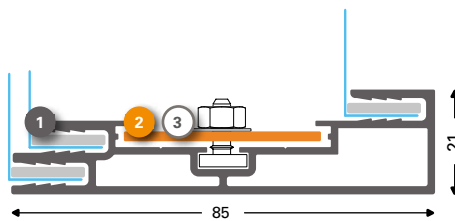

- 1 **131082 (131083\*)**  
T-Flex® 85/2 WG mill
- 2 **130708**  
Cornerconnector FF
- 3 **130709**  
Straight connector FF

**T-Flex® 140/2 WG**  
One-sided

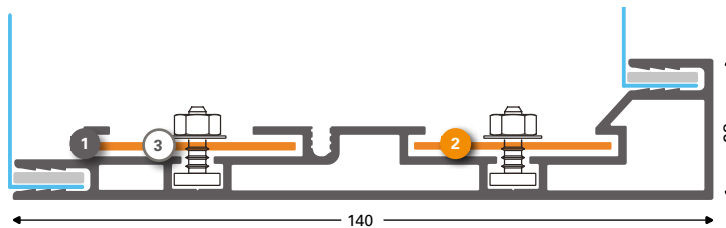

- 1 **131130 (131132\*)**  
T-Flex® 140/2 WG mill
- 2 **130708**  
Cornerconnector FF
- 3 **130709**  
Straight connector FF

\* Anodised profile



# Double-sided illuminated frames



**T-Flex® 60/2**  
Double-sided

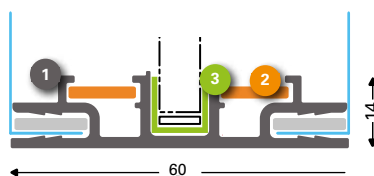

- 1 **131075 (131077\*)**  
T-Flex® 60/2 EdgeLight mill
- 2 **131078**  
Cornerconnector steel 17, 35 & 60
- 3 **137422**  
LED container 10x10x10x1.0 anod L 3000

**T-Flex® 96/2**  
Double-sided

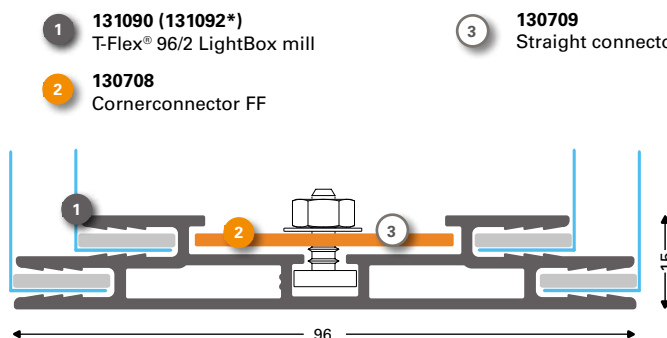

- 1 **131090 (131092\*)**  
T-Flex® 96/2 LightBox mill
- 2 **130708**  
Cornerconnector FF
- 3 **130709**  
Straight connector FF

**SpeeTex® 120/2**

Double-sided

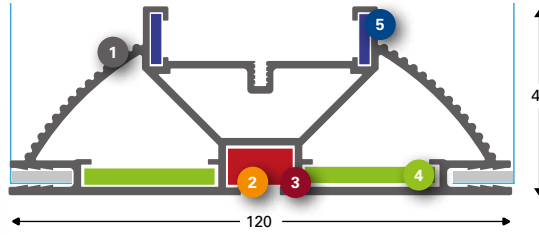
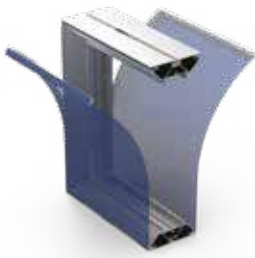

- 1 **131120 (131122\*)**  
SpeeTex® 120/2 mill
- 2 **131165**  
Click-Corner connector external
- 3 **131124**  
SpeeTex® Corner connector 100 hexagon
- 4 **131126**  
SpeeTex® Corner connector 78x78 for 120
- 5 **137154**  
Corner connector L steel hexagon

**SpeeTex® 150/2**

Double-sided

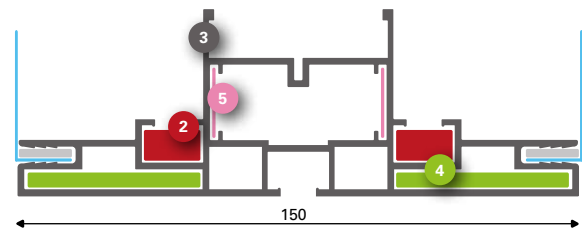
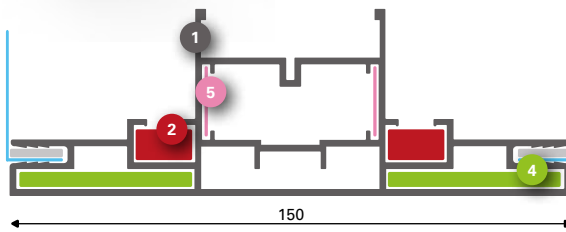
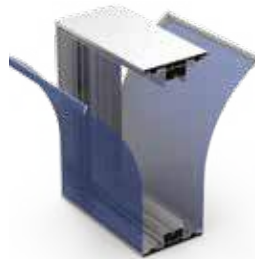

- 1 **131474 (131476\*)**  
Speetex® 150/2 closed mill finish
- 2 **131479**  
Speetex® Corner connector 100 mm hexagon internal (125/150)
- 3 **131470 (131472\*)**  
Speetex® 150/2 open mill
- 4 **131478**  
Corner connector 78 for Speetex® 150
- 5 **131164**  
Support-Corner connector steel 150/160

**T-Flex® 170/2**

Double-sided

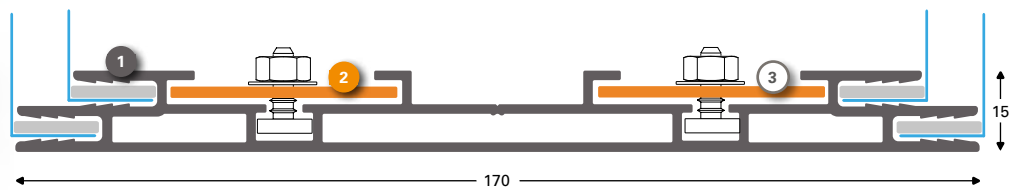

- 1 **131170 (131172\*)**  
T-Flex® 170/2 LightBox mill
- 2 **130708**  
Cornerconnector FF
- 3 **130709**  
Straight connector FF

\* Anodised profile

See page 18-23 for parts and accessories



**T-Flex® Cube**  
Cube

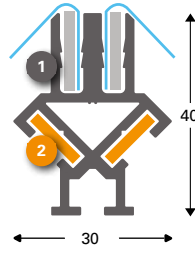

- 1 **131185 (131187\*)**  
T-Flex® Cube Frame mill
- 2 **131180**  
T-Flex® Cube Cornerpiece

**SpeeTex® XXL Cube**  
Cube

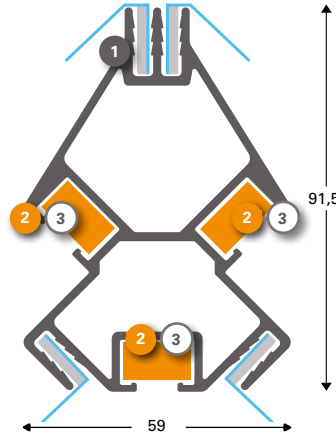

- 1 **131176 (131177\*)**  
SpeeTex® Cube XXL Frameprofile mill
- 2 **131175**  
SpeeTex® Cube XXL Cornerpiece
- 3 **131178**  
Straight connector steel

131175



**SpeeTex® Cube XXL Cornerpiece**

131179



**SpeeTex® Cube XXL  
Stainless steel hangingpiece**

131174



**SpeeTex® Connector for  
reinforcement**

131128



**Cube XXL Foot M16 x 150 mm  
(adjustable)**



**T-Flex® 70 Outdoor**  
One-sided

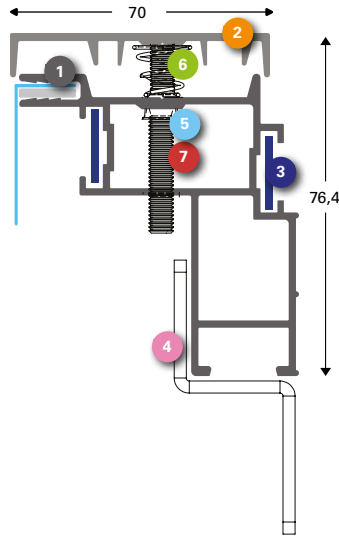

- 1 **131532**  
T-Flex® 70 Outdoor Basicprofile anod
- 2 **131535**  
T-Flex® 70 Outdoor Afdekprofiel vom-1
- 3 **131538**  
T-Flex® 70 Outdoor Stainless steel corner connector
- 4 **131539**  
T-Flex® 70 Outdoor Stainless steel bracket
- 5 **131540**  
T-Flex® 70 Outdoor stainless steel screw ISO 7380
- 6 **131541**  
T-Flex® 70 Outdoor Stainless steel coverspring
- 7 **131542**  
T-Flex® 70 Outdoor Stainless steel blind rivet nut

**MultiFrame®**  
Double-sided

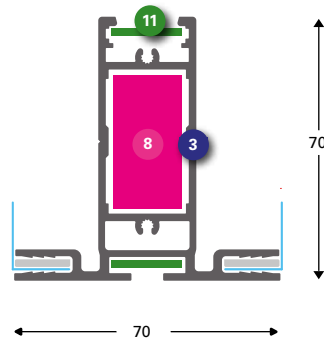
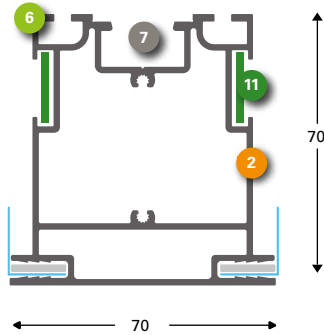
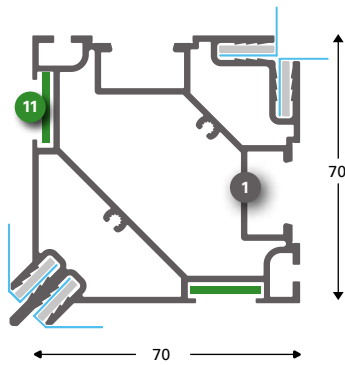

- 1 **131714\* (131716\*\*)**  
MultiFrame® Cornerprofile anod
- 2 **131702\* (131704\*\*)**  
MultiFrame® Sideprofile anod
- 3 **131726\* (131728\*\*)**  
MultiFrame® T-connecting profile anod
- 4 **131708 (131710\*)**  
End cap sideprofile [131702] anod
- 5 **131720 (131722\*)**  
End cap cornerprofile [131714] anod
- 6 **131018**  
Reinforcement profile S anod
- 7 **133613**  
Supporting Profile L anod
- 8 **139758**  
T-connector 40 anod (133613)
- 9 **139738**  
Drilling template T-connector 139758
- 10 **131022**  
Connector straight [131018]
- 11 **131543**  
Stainless straight connector [131724/26 ,131532]

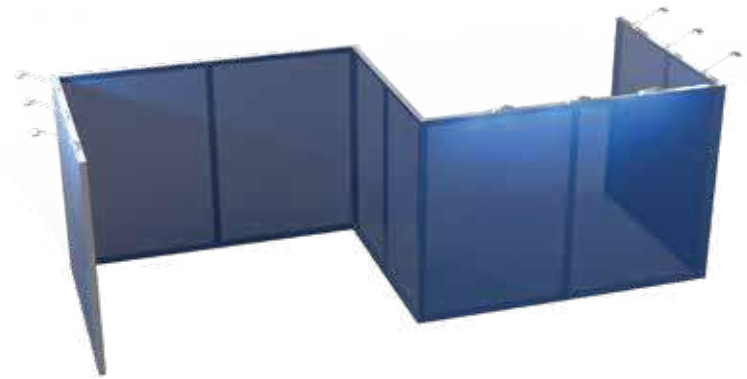
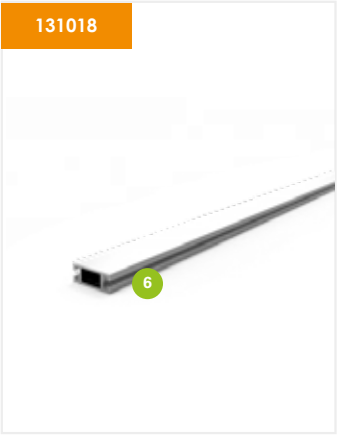
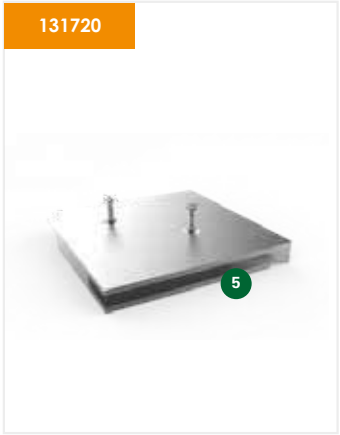
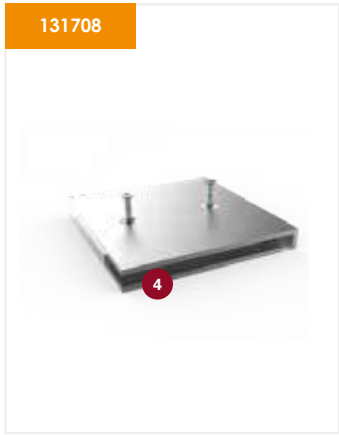

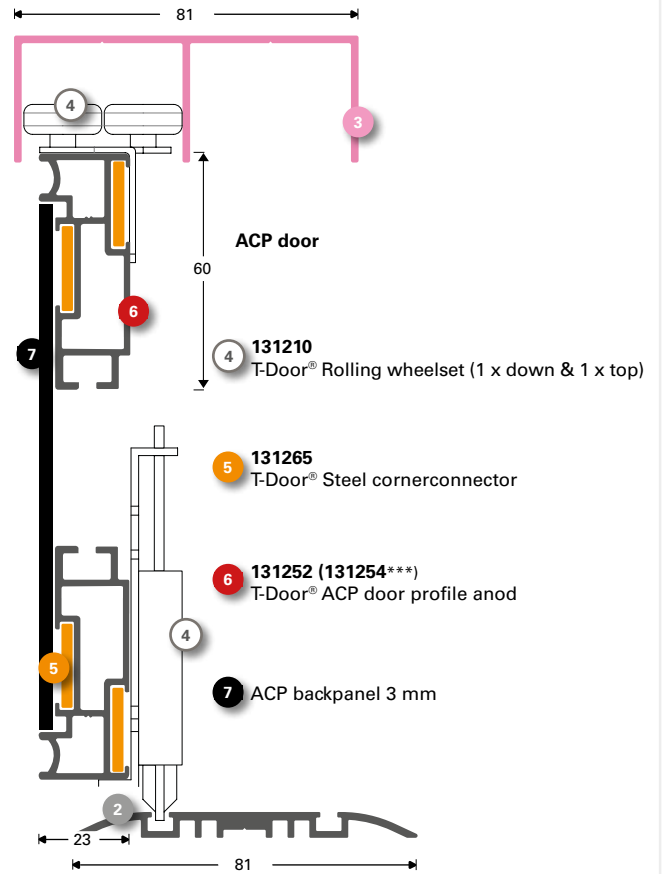
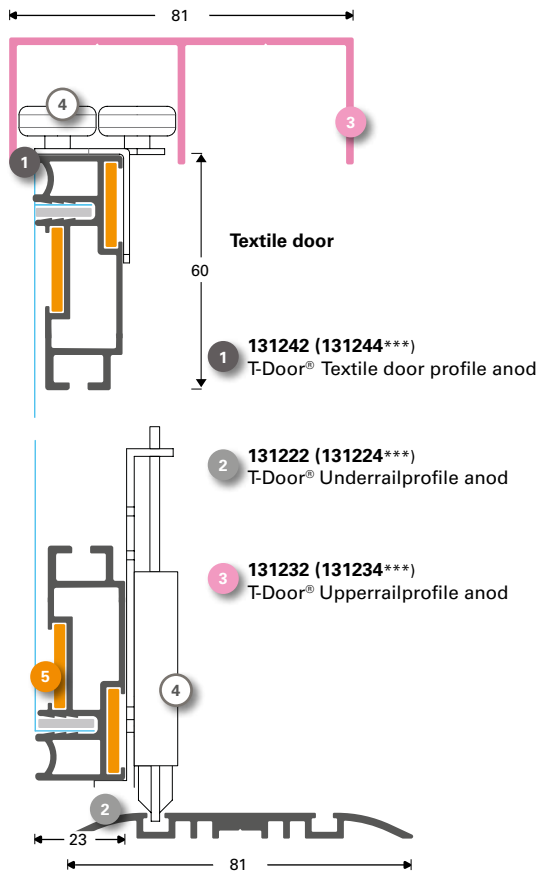

\* Anodised profile \*\* RAL 9003 profile \*\*\* Black anodised profile

# T-Door® Fabric and ACP panel sliding door system



# Keder® Specifications

<b>Sign system:</b>	Kederprofile
<b>Features:</b>	Profiles & Parts for hanging & stretching fabric using keder
<b>Medium:</b>	Textile, PVC cloth & other substrates using keder
<b>Application:</b>	Indoor & outdoor
<b>Variants:</b>	Single & double sided
<b>Profile:</b>	6100 mm, EN AW 6060 T6, mill fi nish or anodised
<b>Parts:</b>	End caps & hanger for 138645/47

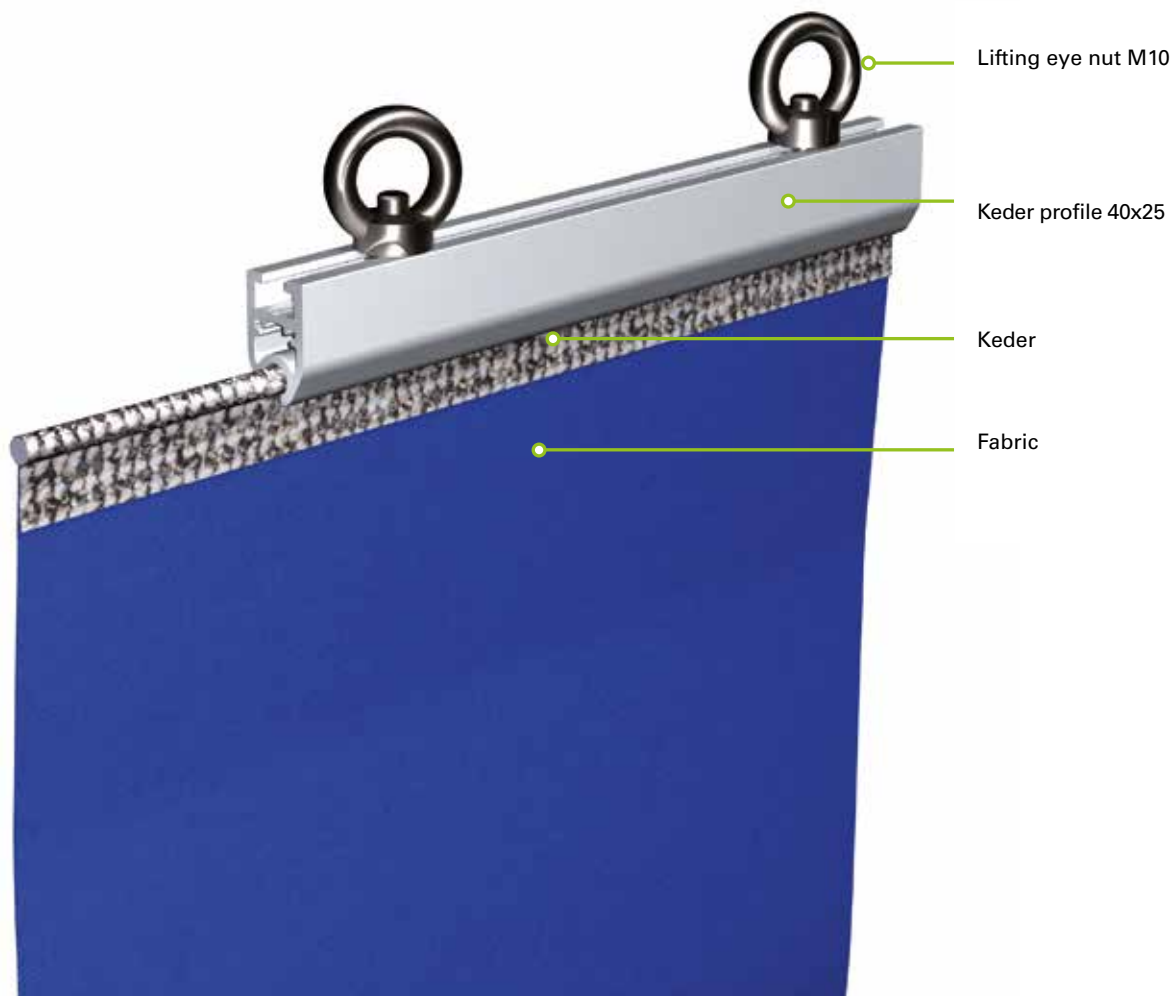
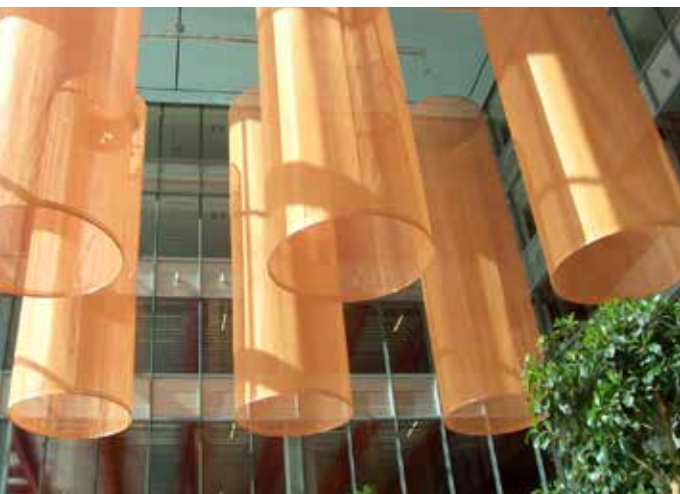

\* Anodised profile



**Keder® 30/2**  
Double-sided

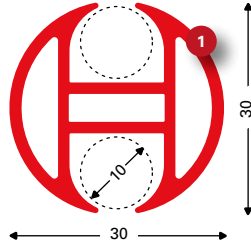

- 1 **138660 (138662\*)**  
Keder profile 30/2 mill
- 138663**  
Plastic end cap Keder 30/2 black
- 2 **138654**  
Straight connector keder 30-44/2 steel
- 3 **138653**  
Hinging connecting part Keder 30-44/2 steel



**Keder® 44/2**  
Double-sided

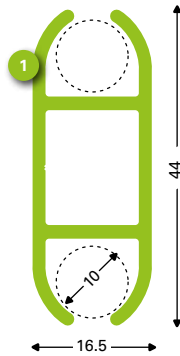

- 1 **138639 (138642\*)**  
Keder profile 44/2 mill
- 138652**  
Plastic end cap 138639/42 grey
- 2 **138655**  
Hanging part M5 with hook keder 30-44/2



**Keder® 40/25**  
One-sided

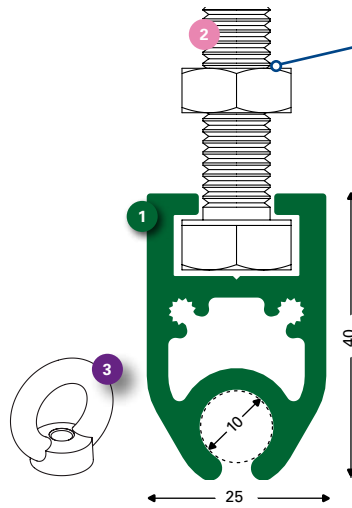

**M10 (138637)**  
Maximum width across 17mm /  
lifting eye nut M10 (**138640**)

- 1 **138645 (138647\*)**  
Keder profile 40x25 mill/anod
- 138648\***  
End cap 138647 anod
- 2 **138641**  
Stainless steel A2 Bolts M10 x 20 DIN 933
- 3 **138640**  
Stainless steel Lifting eye nut M10
- 138656**  
Straight connector keder 40/25 Steel

**Keder® 39/2**  
One-sided

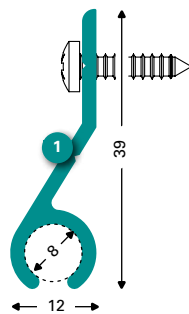

- 1 **134110**  
Keder profile 39x12 mill

# Parts and accessories Tension fabric displays

ORDER  
A SAMPLE  
KIT!

Connectors and supports + straight

131078



Cornerconnector steel 17, 35 & 60

137158



Cornerconnector M Steel hexagon

137154



Cornerconnector L steel hexagon

137620



Corner connector 60x60x5.0 11 mm mill

131124



SpeeTex® Cornerconnector 100 hexagon

130708



Cornerconnector FF

131165



Click-corner connector external

131265



T-Door® Steel Cornerconnector

131538



T-Flex® 70 Outdoor stainless corner connector

131126



SpeeTex® Cornerconnector 78x78

131166



SpeeTex® 160 Cornerpiece 78x78

131025



Only in combination with 137154

T-Flex® ABS corner grey

131026



Only in combination with 137154

T-Flex® ABS corner black

131168



Straight support-connector steel  
(2) 150/160

131478



Cornerconnector 78 for Speetex® 150

Backpanel supports

131059



Backpanel support 50/55 - 40 mm

131089





















Backpanel support 75/85/150 - 40mm

131088

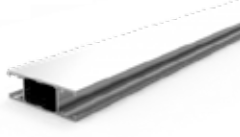

Backpanel support 100 - 40 mm

# Parts and accessories Tension fabric displays

<p>131008</p>  <p>T-Flex® 17 Cornersolution 45 x 45 mm anod</p>	<p>131009</p>  <p>T-Flex® 23 Cornersolution 45x45 mm anod</p>	<p>131011</p>  <p>T-Flex® 46 Cornersolution 45x45 mm anod</p>	<p>137152</p>  <p>Straight connector 100 mm</p>	<p>Assembled corners</p>	
<p>130709</p>  <p>Straight connector FF</p>	<p>131178</p>  <p>Straight connector steel</p>	<p>131169</p>  <p>Adjustable click corner connector</p>	<p>131174</p>  <p>SpeeTex® Connector for reinforcement</p>		<p>Straight connectors:</p>
<p>131030</p>  <p>T-Flex® Hinge anod</p>	<p>131031</p>  <p>T-Flex® Hinge black anod</p>	<p>131479</p>  <p>Speetex® Cornerconnector 100 mm hexagon internal</p>	<p>131164</p>  <p>Support-Corner connectorSteel 150/160</p>		
<p>131708</p>  <p>End cap sideprofile [131702] anod</p>	<p>131720</p>  <p>End cap cornerprofile [131714] anod</p>	<p>133613</p>  <p>Supporting Profile L anod</p>	<p>139758</p>  <p>T-connector 40 anod (133613)</p>		
<p>139738</p>  <p>Drilling template T-connector 139758</p>	<p>131543</p>  <p>Stainless straight connector [131724/26, 131532]</p>				

# Hanging solutions

Supports

131018



Reinforcement profile S anod

131022



Connector straight [131018]

131023



Connector 45 degrees L+R [131018]

131028



45 dg. reinforcement 750 anod

131097



Support bracket 25 mm with holes

131098



Support bracket 25 mm with holes  
(+ 2 nuts & bolts)

131099



Support bracket 25 mm without holes

131174



SpeeTex® Connector for reinforcement

130889



Spacer - reinforcement 40x36  
RAL 9016

131145



Mounting plate for Foot  
[131085/131090]

Feet supports

131338



Foot Wall-Basic Aluminium  
anod L: 223 mm

131118



Foot B Steel 400 x 60 RAL 9006

131340



Foot S-Basic Aluminium anod  
L: 400 mm

131339



Foot M-Basic Aluminium anod  
L: 600 mm

131037



Foot L Aluminium anod

131034



Foot G Aluminium anod

131139



SpeeTex® Foot 500 120/150/160  
anod

131140



SpeeTex® Foot 1 (wall) 330  
120/150/160 anod

# Aluminum, steel & stainless cable

## Solutions for quick installation of sign systems

131079



Adjustable wall mounting hook T-17

131319



Hanging hook T-Flex® 23/30 basic anod

131539



T-Flex® 70 Outdoor stainless steel bracket

131113



Hanging hook T-Flex® 46 basic anod

131111



Wall bracket for T-Flex® 46 anod

131173



Lifting bold M8 stainless steel + block

130655



Hanging set steel cable hook  
3 m T2 stainless steel

131298



Installing hook mill (130297)

138730



Suspensionclip Eco adjustable  
(34,5 x 10 mm side exit)

138734



Suspensionbus cylindrical  
(28,5x12 mm side exit)

138732



Suspensionbus conical  
(40x18 mm side exit)

138751



Adjustable Loop/Cablefixation black 3.0 mm

138752



Adjustable Loop/Cablefixation silver  
(1.5 mm)

138753



Adjustable Loop/Cablefixation black  
(1.5 mm)

138750



Adjustable Loop/Cablefixation  
(3.0 mm) silver

138762



Ceilinggripper with eyelet

138761



Ceilinggripper with adjust.  
cablebus 1.5 mm

138706



Steelcable with ball  
4,5 x 1,5 mm L 1500

138646

















Lifting eye M6 stainless steel

138649



Lifting eye nut M8 stainless steel

# Parts and accessories **Tension fabric displays**

Magnets	<p>139345</p>  <p>Heavy Duty Magnet 32 x 7,0 mm</p>	<p>138710</p>  <p>Heavy Duty Magnet 25 x 8,5 with counterering</p>	<p>138760</p>  <p>Magnetic Anchor 32 mm incl. gripper</p>	<p>131041</p>  <p>Hexagon key 2,5 mm ISO 2936</p>
	<p>131043</p>  <p>Hexagon socketkey 3,0 mm ISO 2936</p>	<p>131024</p>  <p>Torx key for connector [131022/023/027]</p>	<p>131029</p>  <p>T-Flex® Hexagon key (M4) 2,0 mm ISO 2936</p>	<p>131017</p>  <p>Rubberroller 131021</p>
	<p>131464</p>  <p>Keder 12x3 PVC White (roll = 200 m)</p>	<p>131466</p>  <p>Keder 14x3 PVC White (roll = 200 m)</p>	<p>131460</p>  <p>Keder 12x3 PVC transparent (roll = 200 m)</p>	<p>131462</p>  <p>Keder 14x3 PVC transparent (roll = 200 m)</p>
	<p>131020</p>  <p>Keder Silicone transparent 14 x 3 mm</p>	<p>131021</p>  <p>Roll-in rubber grey (200 m)</p>		



ALWAYS  
AVAILABLE  
FROM  
STOCK!

## Trade show booth extrusions

1 **131035\*\***  
T-Flex® Connecting profile anod

2 **131018\***  
Reinforcement profile S anod

3 **131022**  
Connector straight [131018]

4 **131023**  
Connector 45 degrees L+R [131018]

**131024**  
Torx key for connector [131022/023/027]

\* RAL 7021 \*\* RAL 7021 Structure



## Magnet / shelving

1 **139342**  
Magnet shelve carrier anod

2 **139345**  
Heavy Duty magnet 32 x 7,0 mm

**139344**  
End cap magnet shelve carrier anod

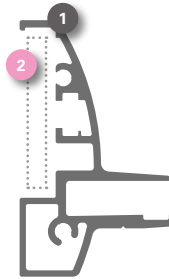

## Sample kits

1 **132251**  
Samplebox T-Flex® Tension fabric displays

2 **132252**  
Samplebox T-Flex® LED Frames + Sample ACP 2 mm

3 **132253**  
Samplebox SpeeTex® Tension fabric displays



# Comhan SEG fabric frames | Eye-catching, Flexible & Versatile

Comhan's T-Flex® SEG-fabric frames provide the perfect means to indoor advertising. Typical areas of application are:

- Shop Windows
- Airports
- Restaurants/Bars
- Museums
- Showrooms
- Trade shows
- Commercial buildings
- Events
- Sliding doors

The T-Flex® series is delivered to the Visual communication industry through sign-makers and companies active in digital printing and advertising.



Call us for more information or make an appointment on +31 (0) 297 513 636

## T-Flex® Tension fabric displays: "Innovation in Visual communication!"

Comhan delivers the T-Flex textile frame, a versatile aluminum frame illuminated and non-illuminated for printed fabric and banners. Quick, easy and flexible. For indoor applications available in single and double sided frames. The T-Flex series includes more than 30 models, ideal for situations where a fabric will be changed regularly.



Frameless Cube



Bend frame



T-Door®

Order your free sign catalog through our website



**COMHANHOLLAND**  
ALUMINIUM

NL • Amsterdamseweg 27 • 1422 AC Uithoorn • Holland  
T +31 (0)297 513 636 • E comhan@comhan.com

DE • Neue Straße 23 • D 58135 Hagen • Deutschland  
T +49 (0)2331 625 1900 • F +49 (0)2331 625 1927 • E comhan@comhan.de