



COMHANHOLLAND
ALUMINIUM

FABRIC FRAMES
FROM STOCK
&
CUSTOM MADE



SEG fabric frames

SILICONE EDGE GRAPHICS FRAMES
FOR PRINTED FABRIC









T-Flex® Fabric frames Specifications

09-03-2020

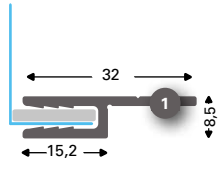
- Sign system:** T-Flex® frameless fabric frames
- Feature:** Profiles & accessories for silicone edge graphics on a wall, freestanding or hanging
- Application:** Changeable, fabric with stitched on silicone keder
- Use:** For indoor illuminated or non-illuminated
- Light source:** Various LED options
- Designed for:** Single and double sided, cube and door applications
- Profile:** 6100 mm, EN AW 6060 T6, mill & anodised
- Parts:** Feet, corner connectors, round corners, supports, support profile and quick connectors.
- Customization:** Easy-to-assemble DIY kit on request

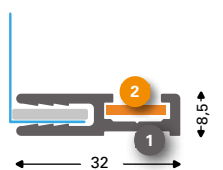

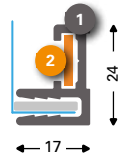
Non-illuminated single & double sided

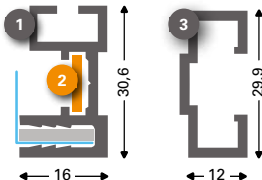
<p>T-Flex® 09 Retro One-sided</p>	 	<p>1 131063* T-Flex® 9/1 Adapterprofile straight anod L 6100</p>
<p>T-Flex® 17 Straight One-sided</p>	 	<p>1 131002 (131004* 131003**) T-Flex® 17/1 Straight mill</p> <p>2 131078 Cornerconnector steel 17, 35 & 60</p> <p>2 137152 Straight connector 100 mm</p>
<p>T-Flex® 17 Mini One-sided</p>	 	<p>1 131005 (131007* 131001** 131006***) T-Flex® 17/1 mill</p> <p>2 137158 Cornerconnector M steel hexagon</p> <p>2 137154 Cornerconnector L steel hexagon</p> <p>2 137152 Straight connector 100 mm</p>
<p>T-Flex® 17/1 + reinforcement detail One-sided</p>	 	<p>1 139130* T-Flex® 17/1 with reinforcement detail anod</p> <p>2 137158 Cornerconnector M steel hexagon</p> <p>2 137154 Cornerconnector L steel hexagon</p> <p>2 137152 Straight connector 100 mm</p> <p>3 139132* T-Flex® 17/1 Underprofile anod</p>

* Anodised profile ** RAL 9003 profile *** Black anodised profile

See page 18-23 for parts and accessories

T-Flex® 32/1
One-sided

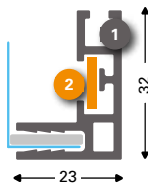

- 1 **131057 (131058*)**
T-Flex® 32/1 LP mill
- 2 **137158**
Cornerconnector M steel hexagon
- 2 **137154**
Cornerconnector L steel hexagon
- 2 **137152**
Straight connector 100 mm

T-Flex® 23/1
One-sided

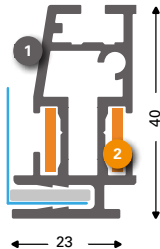

- 1 **131010 (131012*131013***)**
T-Flex® 23/1 mill
- 2 **137158**
Cornerconnector M steel hexagon
- 2 **137154**
Cornerconnector L steel hexagon
- 2 **137152**
Straight connector 100 mm

SpeeTex® 25/1
One-sided

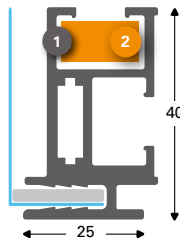

- 1 **131427**
Speetex® 25/1 Brushed anod
- 2 **131420**
SpeeTex® 25/1 Round corner brushed anod

T-Flex® 30/1
One-sided

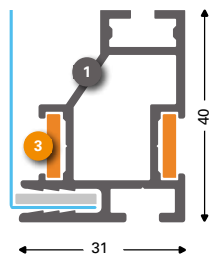

- 1 **131310 (131311*)**
T-Flex® 30/1 Basic mill
- 3 **137158**
Cornerconnector M steel hexagon
- 3 **137152**
Straight connector 100 mm

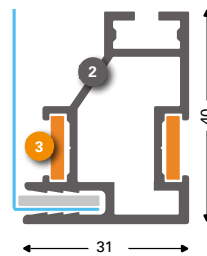

- 2 **131314 (131315*)**
T-Flex® 30/1 Basic closed mill
- 3 **137154**
Cornerconnector L steel hexagon



T-Flex® 35/1
One-sided

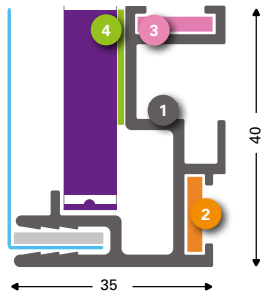

- 1 **131045 (131047* 131046***)**
T-Flex® 35/1 LED-frame mill

- 2 **137158**
Cornerconnector M steel hexagon
- 2 **137154**
Cornerconnector L steel hexagon
- 3 **131078**
Cornerconnector steel 17, 35 & 60
- 4 **3M Tape**

T-Flex® 36/1 Bend Frame
One-sided

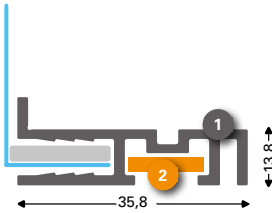

- 1 **131073***
T-Flex® Bendingprofile 36 mm anod

- 2 **137158**
Cornerconnector M steel hexagon
- 2 **137154**
Cornerconnector L steel hexagon
- 2 **137152**
Straight connector 100 mm

T-Flex® 40/2 Mini
One-sided

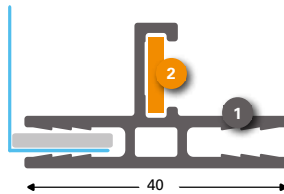

- 1 **131560 (131562*)**
T-Flex® 40/2 Mini mill

- 2 **137158**
Cornerconnector M steel hexagon
- 2 **137154**
Cornerconnector L steel hexagon
- 2 **137152**
Straight connector 100 mm

T-Flex® 40/2 Mini LED
One-sided

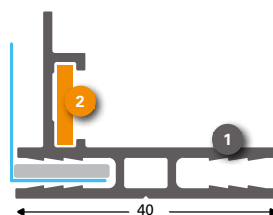

- 1 **131564 (131566*)**
T-Flex®40/2 Mini LED mill

- 2 **137158**
Cornerconnector M steel hexagon
- 2 **137154**
Cornerconnector L steel hexagon
- 2 **137152**
Straight connector 100 mm

T-Flex® 46/2 basic
Double-sided

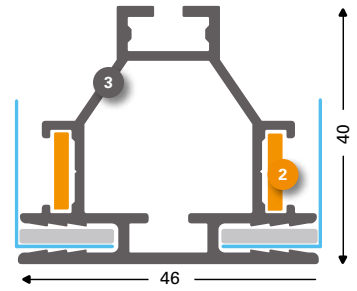
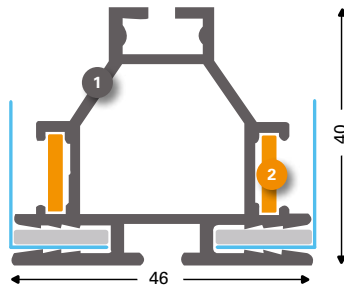

- 1 **131114 (131116*)**
T-Flex® 46/2 Basic mill
- 2 **137158**
Cornerconnector M steel hexagon
- 2 **137154**
Cornerconnector L steel hexagon
- 2 **137152**
Straight connector 100 mm
- 3 **131115 (131117*)**
T-Flex® 46/2 Basic closed mill

T-Flex® 46/2
Double-sided

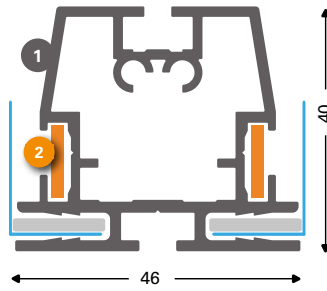

- 1 **131014 (131016* 131015***)**
T-Flex® 46/2 mill
- 2 **137158**
Cornerconnector M steel hexagon
- 2 **137154**
Cornerconnector L steel hexagon
- 2 **137152**
Straight connector 100 mm

T-Flex® 46/2 Bend Frame
Double-sided

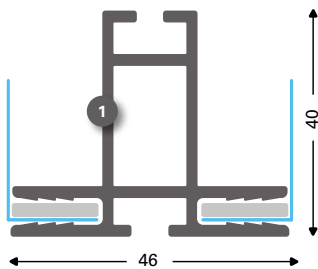

- 1 **131094 (131095*)**
T-Flex® 46/2 BF mill

SpeeTex® 50/2
Double-sided

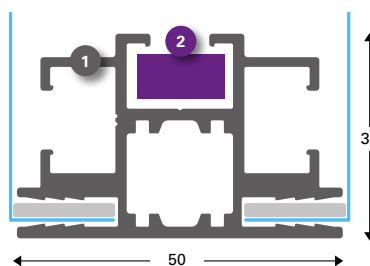

- 1 **131452**
Speetex® 50/2 Brushed anod
- 2 **131450**
SpeeTex® 50/2 Round corner brushed anod



Single-sided illuminated frames

T-Flex® 50/1
One-sided

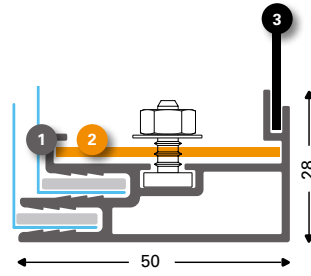

- 1 **131054 (131055*)**
T-Flex® 50/1 LightBox DT mill
 - 2 **130708**
Cornerconnector FF
 - 3 **ACP Back panel Matt white**
Dimension: H-42 mm W-42 mm
- 131059**
T-Flex® 50/55 Back panel support 40 mm

T-Flex® 55/1
One-sided

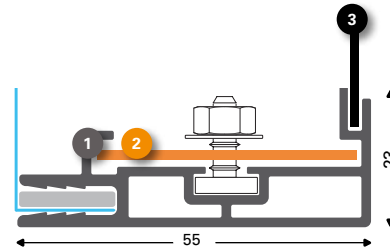

- 1 **131050 (131052*)**
T-Flex® 55/1 LightBox mill
 - 2 **130708**
Cornerconnector FF
 - 3 **ACP 2,0mm Back panel Matt white**
Dimension: H-32 mm W-32 mm
- 131059**
T-Flex® 50/55 Back panel support 40 mm

T-Flex® 85/1
One-sided

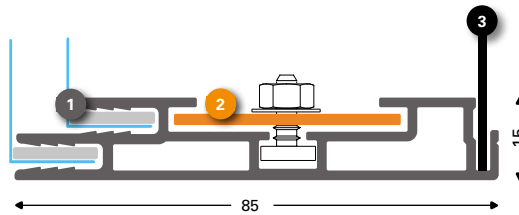

- 1 **131085 (131087*)**
T-Flex® 85/1 LightBox mill
 - 2 **130708**
Cornerconnector FF
 - 3 **ACP 2,0mm Back panel Matt white**
Dimension: H-5 mm W-5 mm
- 131089**
T-Flex® 85/150 Backpanel support 40 mm

T-Flex® 100/1
One-sided

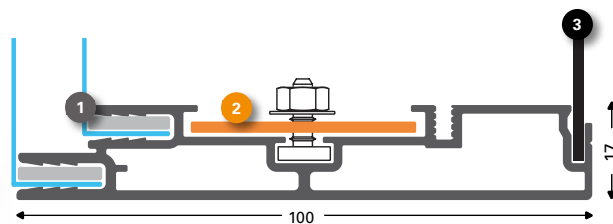

- 1 **131104 (131106*131105*** 131107****)**
T-Flex® 100/1 LightBox mill
 - 2 **130708**
Cornerconnector FF
 - 3 **ACP 2,0mm Back panel Matt white**
Dimension: H-15 mm W-15 mm
- 131088**
T-Flex®100 Back panel support 40 mm

T-Flex® 150/1
One-sided

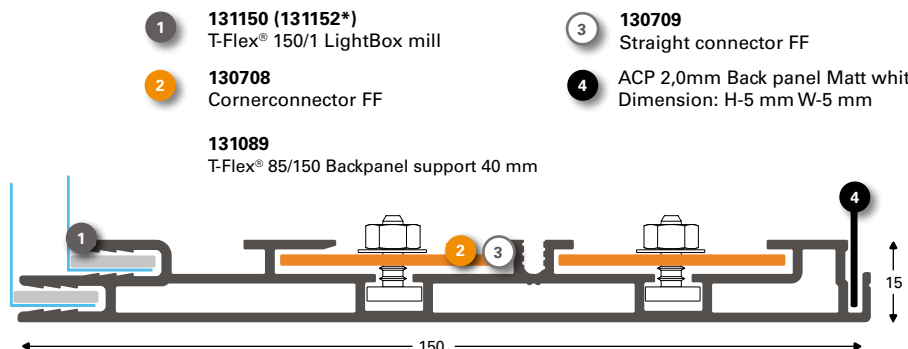

- 1 **131150 (131152*)**
T-Flex® 150/1 LightBox mill
 - 2 **130708**
Cornerconnector FF
 - 3 **130709**
Straight connector FF
 - 4 **ACP 2,0mm Back panel Matt white**
Dimension: H-5 mm W-5 mm
- 131089**
T-Flex® 85/150 Backpanel support 40 mm

Window system



T-Flex® 85/2 WG
One-sided

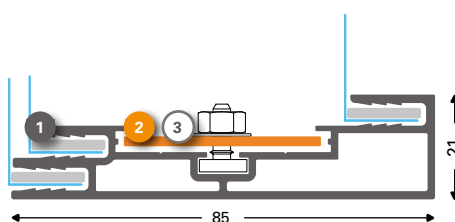

- 1 **131082 (131083*)**
T-Flex® 85/2 WG mill
- 2 **130708**
Cornerconnector FF
- 3 **130709**
Gerade Verbinder FF

T-Flex® 140/2 WG
One-sided

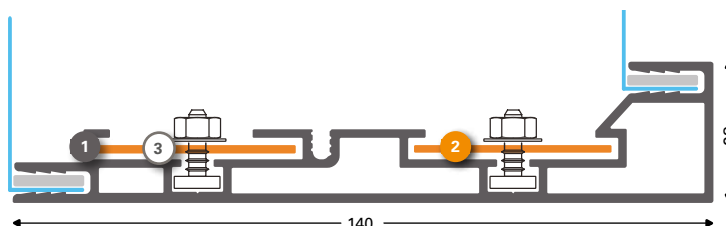

- 1 **131130 (131132*)**
T-Flex® 140/2 WG mill
- 2 **130708**
Cornerconnector FF
- 3 **130709**
Straight connector FF

* Anodised profile

Double-sided illuminated frames



T-Flex® 60/2
Double-sided

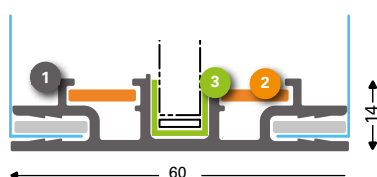

- 1 **131075 (131077*)**
T-Flex® 60/2 EdgeLight mill
- 2 **131078**
Cornerconnector steel 17, 35 & 60
- 3 **137422**
LED container 10x10x10x1.0 anod L 3000

T-Flex® 96/2
Double-sided

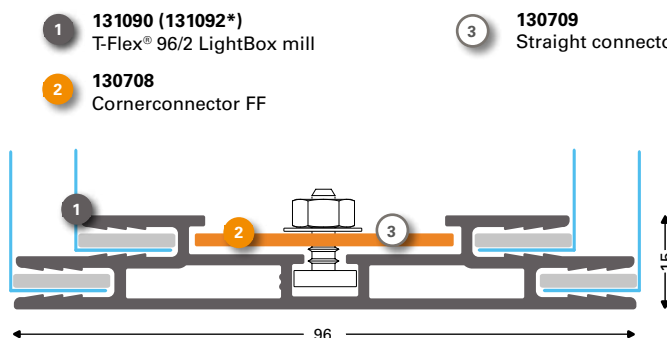
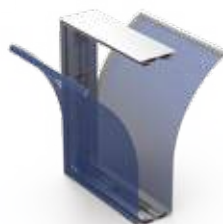

- 1 **131090 (131092*)**
T-Flex® 96/2 LightBox mill
- 2 **130708**
Cornerconnector FF
- 3 **130709**
Straight connector FF

SpeeTex® 120/2
Double-sided

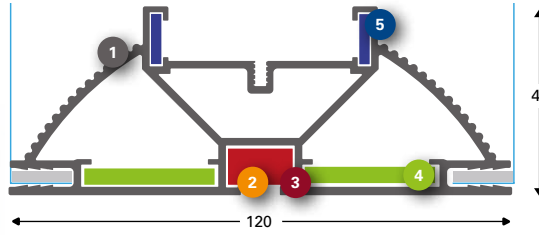

- 1 **131120 (131122*)**
SpeeTex® 120/2 mill
- 2 **131165**
Click-Corner connector external
- 3 **131124**
SpeeTex® Cornerconnector 100 hexagon
- 4 **131126**
SpeeTex® Cornerconnector 78x78 for 120
- 5 **137154**
Cornerconnector L steel hexagon

SpeeTex® 150/2
Double-sided

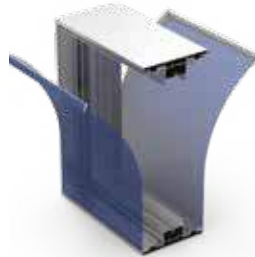

- 1 **131474 (131476*)**
Speetex® 150/2 closed mill finish
- 2 **131479**
Speetex® Cornerconnector 100mm hexagon internal (125/150)

- 3 **131470 (131472*)**
Speetex® 150/2 open mill

- 4 **131478**
Cornerconnector 78 for Speetex® 150
- 5 **131164**
Support-Cornerconnector Steel 150/160

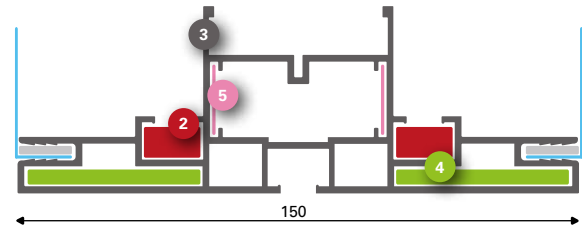
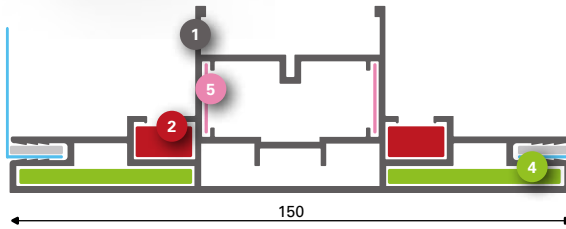

SpeeTex® 160/2
Double-sided

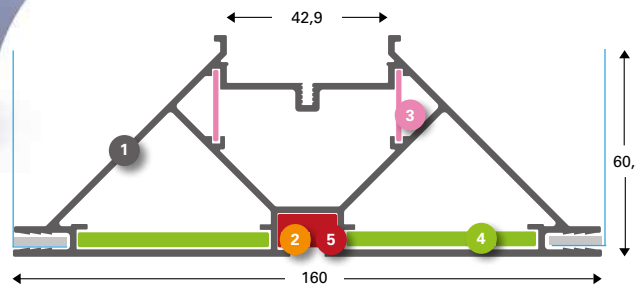

- 1 **131160 (131162*)**
SpeeTex® 160/2 mill
- 2 **131165**
Click-Corner connector external
- 3 **131164**
Support-cornerconnector Steel 150/160
- 4 **131166**
SpeeTex® 160 Cornerpiece 78x78
- 5 **131124**
SpeeTex® cornerconnector 100 hexagon

T-Flex® 170/2
Double-sided

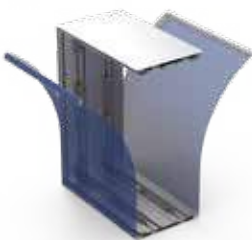

- 1 **131170 (131172*)**
T-Flex® 170/2 LightBox mill

- 2 **130708**
Cornerconnector FF

- 3 **130709**
Straight connector FF



T-Flex® Cube
Cube

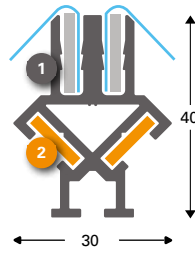

- 1 **131185 (131187*)**
T-Flex® Cube Frame mill
- 2 **131180**
T-Flex® Cube Cornerpiece

SpeeTex® XXL Cube
Cube

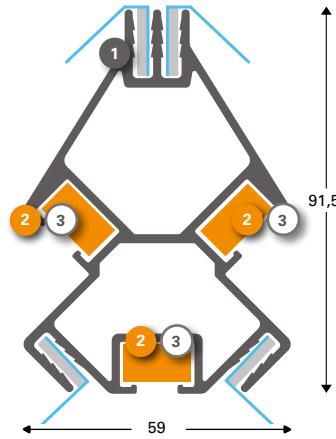

- 1 **131176 (131177*)**
SpeeTex® Cube XXL Frameprofile mill
- 2 **131175**
SpeeTex® Cube XXL Cornerpiece
- 3 **131178**
Straight connector steel

131175



SpeeTex® Cube XXL Cornerpiece

131179



**SpeeTex® Cube XXL
Stainless steel hangingpiece**

131174



**SpeeTex® Connector for
reinforcement**

131128



**Cube XXL Foot M16 x 150 mm
(adjustable)**



T-Flex® 70 Outdoor
One-sided

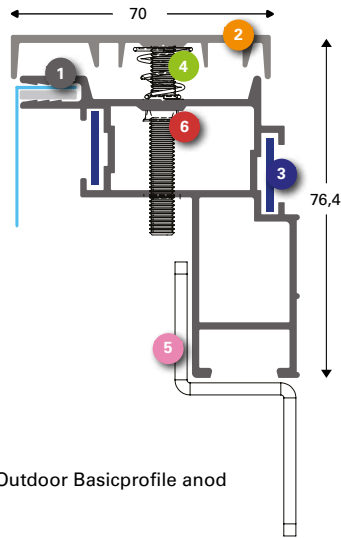

1 131532
T-Flex® 70 Outdoor Basicprofile anod

- 2 131535**
T-Flex® 70 Outdoor Coverprofile anod
- 3 131538**
T-Flex® 70 Outdoor Stainless steel corner connector
- 4 131541**
T-Flex® 70 Outdoor Stainless steel coverspring
- 5 131539**
T-Flex® 70 Outdoor Stainless steel bracket
- 6 131542**
T-Flex® 70 Outdoor Stainless steel blind rivet nut

MultiFrame®
Double-sided

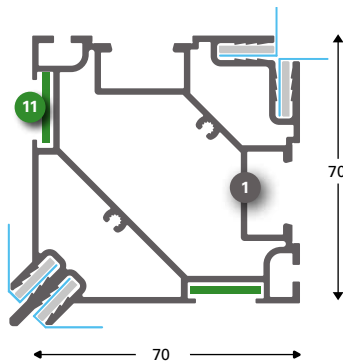

1 131714* (131716)**
MultiFrame® Cornerprofile anod

2 131702* (131704)**
MultiFrame® Sideprofile anod

3 (131726* (131728))**
MultiFrame® T-connecting profile anod

4 131708* (131710)**
End cap sideprofile [131702] anod

5 131720* (131722)**
End cap cornerprofile [131714] anod

6 131018
Reinforcement profile S anod

7 133613
Supporting Profile L anod

8 139758
T-connector 40 anod (133613)

9 139738
Drilling template T-connector 139758

10 131022
Connector straight [131018]

11 131543
Stainless straight connector [131724/26 ,131532]

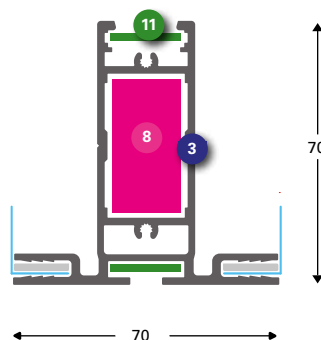
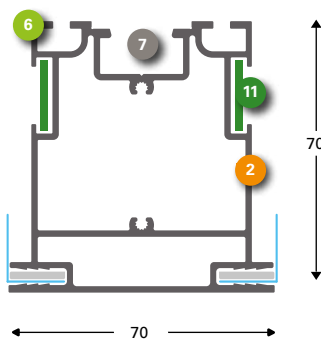

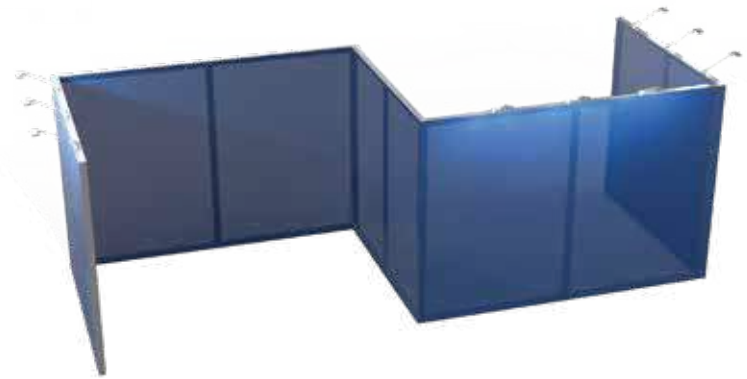
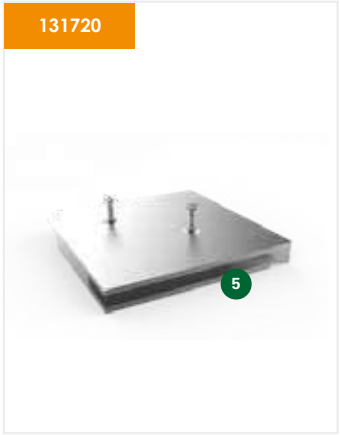
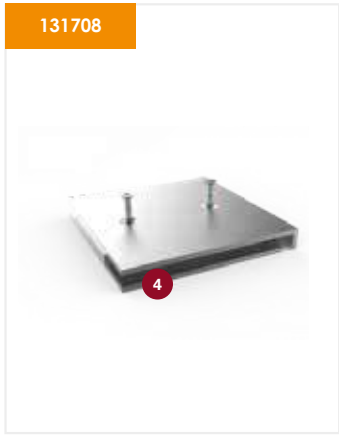

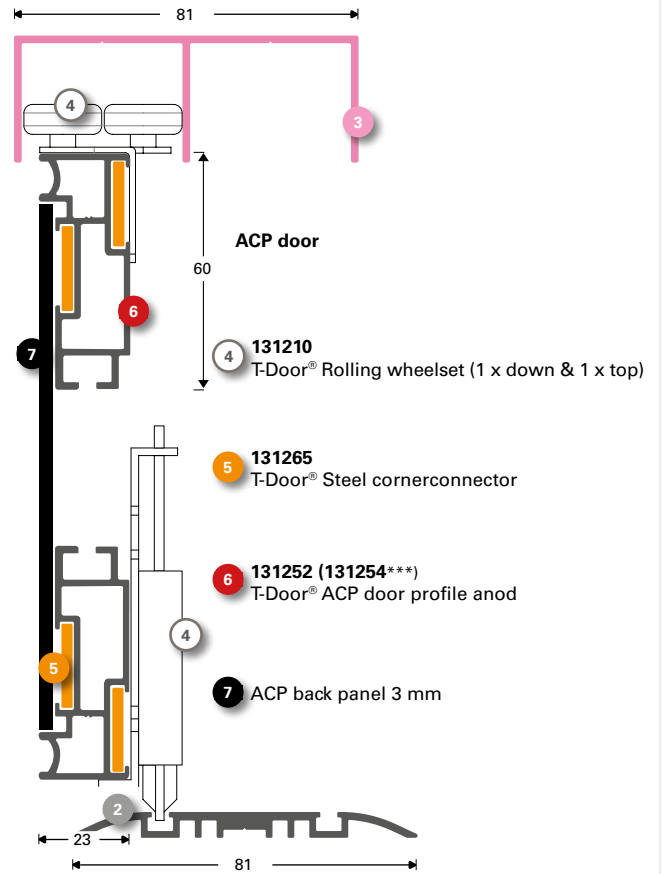
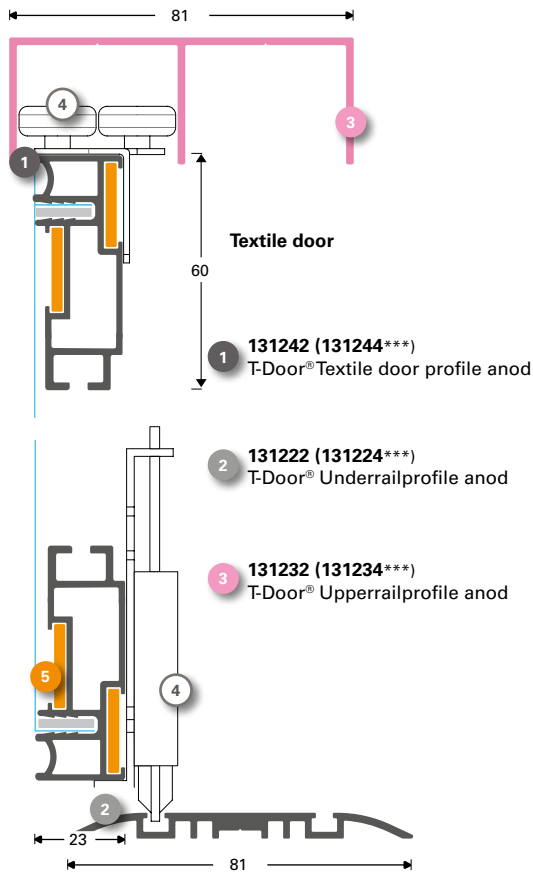

* Anodised profile ** RAL 9003 profile *** Black anodised profile

T-Door® Fabric and ACP panel sliding door system



Keder® Specifications

Sign system:	Kederprofile
Feature:	Profiles & components for hanging & stretching fabric using keder
Medium:	Textile, PVC cloth & other substrates using keder
Usage:	Indoor & outdoor
Variants:	Single & double sided
Profile:	6100 mm, EN AW 6060 T6, mill finish or anodised
Parts:	End caps & hanger for 138645/47

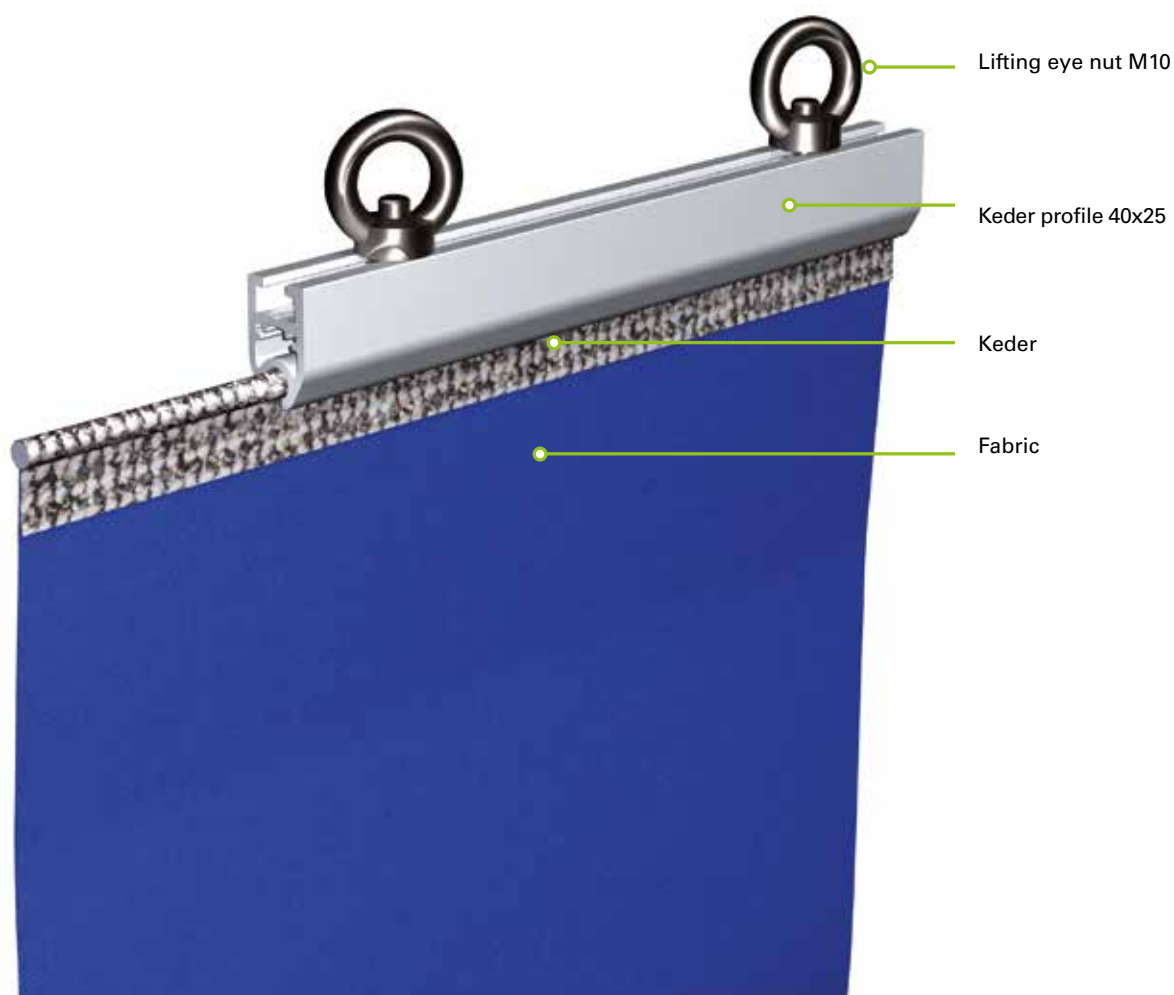

Keder® 30/2
Double-sided

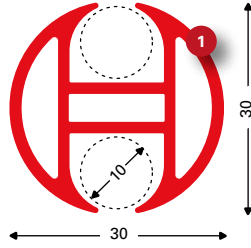

- 1 138660/138662***
Kederprofile 30/2 mill/anod
- 138663**
Plastic end cap Keder 30/2 black
- 2 138654**
Straight connector keder 30-44/2 steel
- 3 138653**
Hinging connecting part Keder 30-44/2 steel



Keder® 44/2
Double-sided

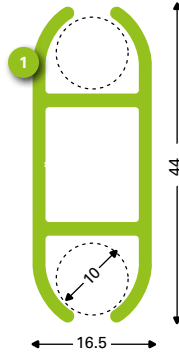

- 1 138639/138642***
Keder profile 44/2 mill/anod
- 138652**
Plastic end cap Keder 44/2 grey
- 2 138655**
Hanging part M5 with hook keder 30-44/2



Keder® 40/25
One-sided

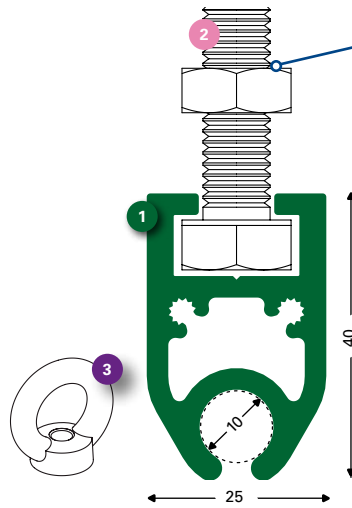

M10
Maximum width across 17mm/ lifting eye nut M10

- 1 138645/138647***
Keder profile 40x25 mill/anod
- 138648**
End cap 138647 anod
- 2 138641**
Stainless steel A2 Bolts M10 x 20 DIN 933
- 3 138640**
Stainless steel Lifting eye nut M10

Keder® 39/2
One-sided

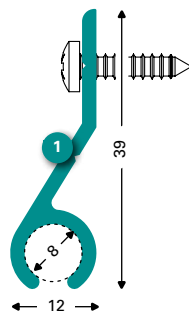

- 1 134110**
Keder profile 39 x 12 mill

ORDER
A SAMPLE
KIT!

Connectors and supports + straight

131078



Cornerconnector steel 17, 35 & 60

137158



Cornerconnector M Steel hexagon

137154



Cornerconnector L steel hexagon

137620



Corner connector 60x60x5.0 11 mm mill

131124



SpeeTex® Cornerconnector 100 hexagon

130708



Cornerconnector FF

131165



Click-corner connector external

131265



T-Door® Steel Cornerconnector

131538



T-Flex® 70 Outdoor stainless corner connector

131126



SpeeTex® Cornerconnector 78x78

131166



SpeeTex® 160 Cornerpiece 78x78

131025



Only in combination with 137154

T-Flex® ABS corner grey

131026



Only in combination with 137154

T-Flex® ABS corner black

131168



Straight support-connector steel
(2) 150/160

131478



Cornerconnector 78 for Speetex® 150

131059



T-Flex® 50/55 Back panel support 40 mm

131089



T-Flex® 85/150 Back panel support 40 mm

131088



T-Flex® 100 Back panel support 40 mm



Back panel supports

131008



T-Flex® 17 Cornersolution 45 x 45 mm anod

131009



T-Flex® 23 Cornersolution 45x45 mm anod

131011



T-Flex® 46 Cornersolution 45x45 mm anod

137152



Straight connector 100 mm

130709



Straight connector FF

131178



Straight connector steel

131169



Adjustable click corner connector

131174



SpeeTex® Connector for reinforcement

131030



T-Flex® Hinge anod

131031



T-Flex® Hinge black anod

131479



Speetex® Cornerconnector 100 mm hexagon internal

131164



Support-cornerconnector Steel 150/160

131708



End cap Sideprofile [131702] anod

131720



End cap Cornerprofile [131714] anod

133613



Supporting Profile L anod

139758



T-connector 40 anod (133613)

139738



Drilling template T-connector 139758

131543



Stainless straight connector [131724/26, 131532]



Assembled corners

Straight connectors:

Supports

131018



Reinforcement profile S anod

131022



Connector straight [131018]

131027



Steel connector Heavy Duty [131018]

131023



Connector 45 degrees L+R [131018]

131028



45 dg. reinforcement 750 anod

130889



Spacer - reinforcement 40x36 RAL 9016

131098



T-Flex® support bracket 25 mm with holes

131174



SpeeTex® Connector for reinforcement

Feet supports

131338



Foot Wall-Basic Aluminium anod L: 223 mm

131118



Foot B Steel 400 x 60 RAL 9006

131340



Foot S-Basic Aluminium anod L: 400 mm

131339



Foot M-Basic Aluminium anod L: 600 mm

131037



Foot L Aluminium anod

131034



Foot G Aluminium anod

131139



SpeeTex® Foot 500 120/150/160 anod

131140



SpeeTex® Foot 1 (wall) 330 120/150/160 anod























131145

















Mounting plate for foot [131085/131090]

Aluminum, steel & stainless cable

Solutions for quick installation of sign systems

<p>131079</p>  <p>Adjustable wall mounting hook T-17</p>	<p>131319</p>  <p>Hanging hook T-Flex® 23/30 basic anod</p>	<p>131539</p>  <p>T-Flex® 70 Outdoor stainless steel bracket</p>	<p>131113</p>  <p>Hanging hook T-Flex® 46 basic anod</p>
<p>131111</p>  <p>Wall bracket for T-Flex® 46 anod</p>	<p>131173</p>  <p>Lifting bold M8 stainless steel + block</p>	<p>130655</p>  <p>Hanging set steel cable hook 3 m T2 stainless steel</p>	<p>131298</p>  <p>T-Flex® support bracket 25 mm with holes</p>
<p>138730</p>  <p>Suspensionclip Eco adjustable (34,5 x 10 mm side exit)</p>	<p>138734</p>  <p>Suspensionbus cylindrical (28,5x12 mm side exit)</p>	<p>138732</p>  <p>Suspensionbus conical (40x18 mm side exit)</p>	<p>138751</p>  <p>Adjustable Loop/Cablefixation black 3.0 mm</p>
<p>138752</p>  <p>Adjustable Loop/Cablefixation silver (1.5 mm)</p>	<p>138753</p>  <p>Adjustable Loop/Cablefixation black (1.5 mm)</p>	<p>138750</p>  <p>Adjustable Loop/Cablefixation (3.0 mm) silver</p>	<p>138762</p>  <p>Ceilinggripper with eyelet</p>
<p>138761</p>  <p>Ceilinggripper with adjust. cablebus 1.5 mm</p>	<p>138706</p>  <p>Steelcable with ball 4,5 x 1,5 mm L 1500</p>	<p>138646</p>  <p>Lifting eye M6 stainless steel</p>	<p>138649</p>  <p>Lifting eye nut M8 stainless steel</p>

Magnets	<p>139345</p>  <p>Heavy Duty Magnet 32 x 7,0 mm</p>	<p>138710</p>  <p>Heavy Duty Magnet 25 x 8,5 with counterering</p>	<p>138760</p>  <p>Magnetic Anchor 32 mm incl. gripper</p>	<p>131041</p>  <p>Hexagon key 2.5 mm ISO 2936</p>
	<p>131043</p>  <p>Hexagon socketkey 3.0 mm ISO 2936</p>	<p>131024</p>  <p>Torx key for connector [131022/023/027]</p>	<p>131029</p>  <p>T-Flex® Hexagon key (M4) 2.0 mm ISO 2936</p>	<p>131017</p>  <p>Rubberroller 131021</p>
	<p>131464</p>  <p>Keder 12x3 PVC White (roll = 200 m)</p>	<p>131466</p>  <p>Keder 14x3 PVC White (roll = 200 m)</p>	<p>131460</p>  <p>Keder 12x3 PVC transparent (roll = 200 m)</p>	<p>131462</p>  <p>Keder 14x3 PVC transparent (roll = 200 m)</p>
	<p>131020</p>  <p>Keder Silicone transparent 14 x 3 mm</p>	<p>131021</p>  <p>Roll-in rubber grey (200 m)</p>		



ALWAYS AVAILABLE FROM STOCK!

Trade show booth extrusions

- 1 131035**
T-Flex® Connecting profile anod
- 2 131018**
Reinforcement profile S anod
- 3 131022**
Connector straight [131018]
- 4 131027**
Steel connector Heavy Duty [131018]
- 5 131023**
Connector 45 degrees L+R [131018]
- 131024**
Torx key for connector [131022/023/027]



Magnet / shelving

- 1 139342**
Magnet shelve carrier anod
- 2 139345**
Heavy Duty magnet 32 x 7,0 mm
- 139344**
End cap magnet shelve carrier anod

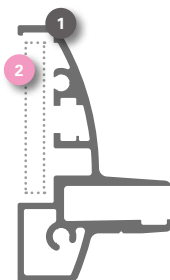

Sample kits

- 1 132251**
Samplebox T-Flex® Tension fabric displays
- 2 132252**
Samplebox T-Flex® LED Frames + Sample ACP 2 mm
- 3 132253**
Samplebox SpeeTex® Tension fabric displays



Comhan SEG fabric frames | Eye-catching, Flexible & Versatile

Comhan's T-Flex® SEG-fabric frames provide the perfect means to indoor advertising. Typical areas of application are:

- Shop Windows
- Airports
- Restaurants/Bars
- Museums
- Showrooms
- Trade shows
- Commercial buildings
- Events
- Sliding doors

The T-Flex® series is delivered to the Visual communication industry through sign-makers and companies active in digital printing and advertising.



Call us for more information or make an appointment on +31 (0) 297 513 636

T-Flex® Tension fabric displays: "Innovation in Visual communication!"

Comhan delivers the T-Flex textile frame, a versatile aluminum frame illuminated and non-illuminated for printed fabric and banners. Quick, easy and flexible. For indoor applications available in single and double sided frames. The T-Flex series includes more than 30 models, ideal for situations where a fabric will be changed regularly.



Frameless Cube



Bend frame



T-Door®

Order your free sign catalog through our website



COMHANHOLLAND
ALUMINIUM

NL • Joh. Enschedeweg 11 • 1422 DR Uithoorn • Holland
T +31 (0)297 513 636 • F +31 (0)297 513 639 • E comhan@comhan.com

DE • Neue Straße 23 • D 58135 Hagen • Deutschland
T +49 (0)2331 625 1900 • F +49 (0)2331 625 1927 • E comhan@comhan.de