



**COMHANHOLLAND**  
ALUMINIUM

ALUSYSTEME  
AB LAGER  
LIEFERBAR  
&  
NACH MAß



# Textilspannrahmen

RANDLOSE ALU-SPANNRAHMEN FÜR BEDRUCKTE TEXTILIEN



# T-Flex® Textilrahmen Spezifikationen

- Sign System:** T-Flex® Rahmenlose Textil-Spannrahmen
- Eigenschaften:** Profile & Teile für das rahmenlose Aufspannen von bedruckten Textilien an der Wand, freistehend oder hängend
- Medium:** Wechselbar, Textildruck mit angenähertem Silikon- oder PVC-Keder
- Einsatz:** Innenanwendung, beleuchtet und unbeleuchtet
- Beleuchtung:** Verschiedene LED-Lösungen
- Ausführung:** Ein- und doppelseitig sowie Kubus-Ausführung
- Profil:** 6100 mm, EN AW 6060 T6, roh & eloxiert
- Zubehör:** Eckverbinder, runde Eckverbinder, Rückwandhalter, Verstärkungsprofile und Schnellverbinder
- Profile nach Maß:** Als Bausatz für schnelle und einfache Montage



## Unbeleuchtet ein- & doppelseitig

<b>T-Flex® 09 Retro</b> Einseitig		<p>1 <b>131063*</b> T-Flex® 9/1 Adapterprof. elox L 6100</p>
<b>T-Flex® 17 Gerade</b> Einseitig		<p>1 <b>131002 (131004* 131003**)</b> T-Flex® 17/1 Gerade roh</p> <p>2 <b>131078</b> Eckverbinder Stahl 17, 35 &amp; 60</p> <p>2 <b>137152</b> Gerade Verbinder 100 mm</p>
<b>T-Flex® 17 Mini</b> Einseitig		<p>1 <b>131005 (131007* 131001** 131006***)</b> T-Flex® 17/1 Mini roh</p> <p>2 <b>137158</b> Eckverbinder M Stahl Inbus</p> <p>2 <b>137154</b> Eckverbinder L Stahl Inbus</p> <p>2 <b>137152</b> Gerade Verbinder 100 mm</p>
<b>T-Flex® 17/1 + Aussteifungsdetail</b> Einseitig		<p>1 <b>139130*</b> T-Flex® 17/1 mit Aussteifungsdetail elox</p> <p>2 <b>137158</b> Eckverbinder M Stahl Inbus</p> <p>2 <b>137154</b> Eckverbinder L Stahl Inbus</p> <p>2 <b>137152</b> Gerade Verbinder 100 mm</p> <p>3 <b>139132*</b> T-Flex® 17/1 Untenprofil elox</p>

\* eloxiert Profil \*\* RAL 9003 Profil \*\*\* Schwarz eloxiert Profil

**T-Flex® 32/1**  
Einseitig

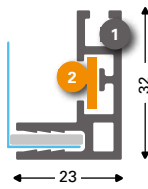

- 1 **131057 (131058\*)**  
T-Flex® 32/1 LP roh
- 2 **137158**  
Eckverbinder M Stahl Inbus
- 2 **137154**  
Eckverbinder L Stahl Inbus
- 2 **137152**  
Gerade Verbinder 100 mm

**T-Flex® 23/1**  
Einseitig

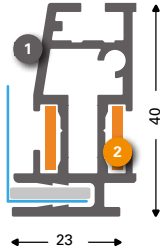
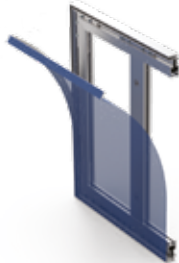

- 1 **131010 (131012\*)**  
T-Flex® 23/1 roh
- 2 **137158**  
Eckverbinder M Stahl Inbus
- 2 **137154**  
Eckverbinder L Stahl Inbus
- 2 **137152**  
Gerade Verbinder 100 mm

**SpeeTex® 25/1**  
Einseitig

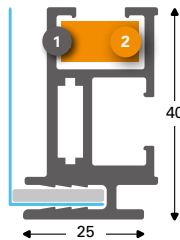
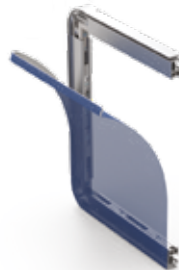

- 1 **131427**  
Speetex® 25/1 Gebürstet elox
- 2 **131420**  
SpeeTex® 25/1 Eckverbinder rund gebürstet elox

**T-Flex® 30/1**  
Einseitig

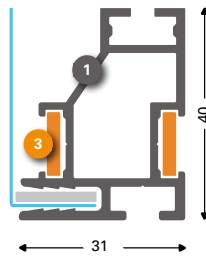

- 1 **131310 (131311\*)**  
T-Flex® 30/1 Basic roh
- 3 **137158**  
Eckverbinder M Stahl Inbus
- 3 **137152**  
Gerade Verbinder 100 mm

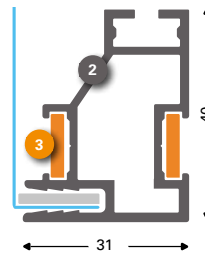

- 2 **131314 (131315\*)**  
T-Flex® 30/1 Basic geschlossen roh
- 3 **137154**  
Eckverbinder L Stahl Inbus



**T-Flex® 35/1**  
Einseitig

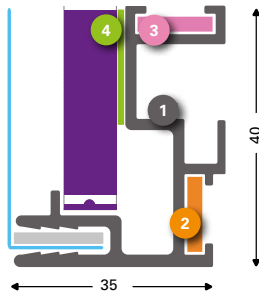
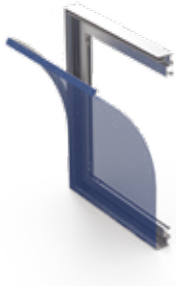

1 **131045 (131047\* 131046\*\*\*)**  
T-Flex® 35/1 LED-Rahmen roh

- 2 **137158**  
Eckverbinder M Stahl Inbus
- 2 **137154**  
Eckverbinder L Stahl Inbus
- 3 **131078**  
Eckverbinder Stahl 17, 35 & 60
- 4 **3M Tape**

**T-Flex® 36/1 Biegeprofil**  
Einseitig

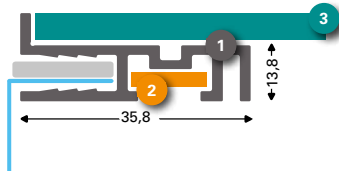
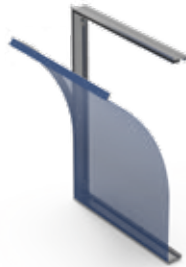

1 **131073\***  
T-Flex® Biegeprofil 36 mm elox

- 2 **137158**  
Eckverbinder M Stahl Inbus
- 2 **137154**  
Eckverbinder L Stahl Inbus
- 2 **137152**  
Gerade Verbinder 100 mm
- 3 **ACP 2 mm Verbundplatte Matt Weiß**  
Maß: H-42 mm W-42 mm

**T-Flex® 40/2**  
Einseitig

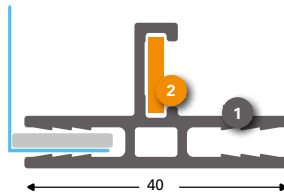

1 **131560 (131562\*)**  
T-Flex® 40/2 roh

- 2 **137158**  
Eckverbinder M Stahl Inbus
- 2 **137154**  
Eckverbinder L Stahl Inbus
- 2 **137152**  
Gerade Verbinder 100 mm
- 3 **ACP 2 mm Verbundplatte Matt Weiß**  
Maß: H-42 mm W-42 mm

**T-Flex® 40/2 LED**  
Einseitig

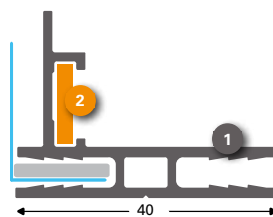

1 **131564 (131566\*)**  
T-Flex® 40/2 LED roh

- 2 **137158**  
Eckverbinder M Stahl Inbus
- 2 **137154**  
Eckverbinder L Stahl Inbus
- 2 **137152**  
Gerade Verbinder 100 mm

**T-Flex® 46/2 basic**  
Doppelseitig

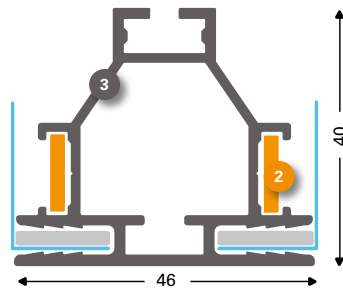
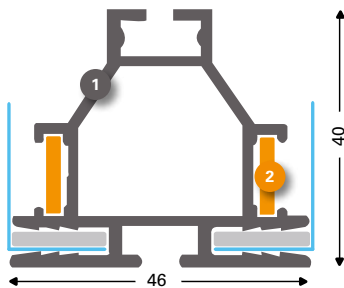
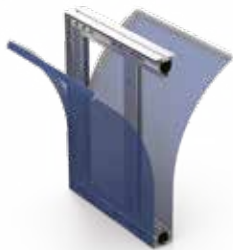

- 1 **131114 (131116\*)**  
T-Flex® 46/2 Basic open roh
- 2 **137158**  
Eckverbinder M Stahl Inbus
- 2 **137154**  
Eckverbinder L Stahl Inbus
- 2 **137152**  
Gerade Verbinder 100 mm

- 3 **131115 (131117\*)**  
T-Flex® 46/2 Basic geschlossen roh

Zubehörteile ab Seite 18 an 23

**T-Flex® 46/2**  
Doppelseitig

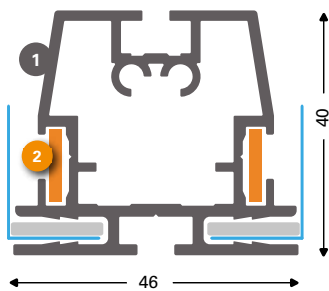
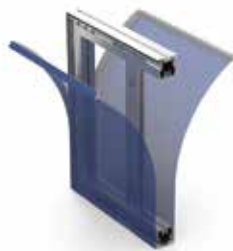

- 1 **131014 (131016\* 131015\*\*\*)**  
T-Flex® 46/2 roh
- 2 **137158**  
Eckverbinder M Stahl Inbus
- 2 **137154**  
Eckverbinder L Stahl Inbus
- 2 **137152**  
Gerade Verbinder 100 mm





# Einseitig beleuchtete Rahmen

**T-Flex® 50/1**  
Einseitig

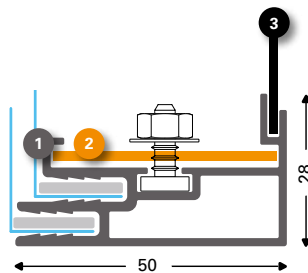

- 1 **131054 (131055\*)**  
T-Flex® 50/1 LightBox DT roh
  - 2 **130708**  
Eckverbinder FF
  - 3 **ACP 2 mm Verbundplatte Matt Weiß**  
Maß: H-42 mm W-42 mm
- 131059**  
Rückwandhalter 50/55 - 40 mm

**T-Flex® 55/1**  
Einseitig

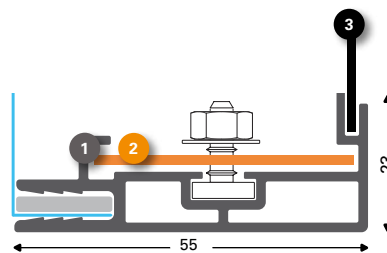
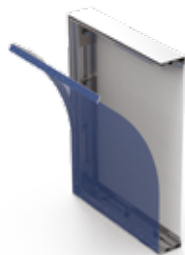

- 1 **131050 (131052\*)**  
T-Flex® 55/1 LightBox roh
  - 2 **130708**  
Eckverbinder FF
  - 3 **ACP 2 mm Verbundplatte Matt Weiß**  
Maß: H-32 mm W-32 mm
- 131059**  
Rückwandhalter 50/55 - 40 mm

**T-Flex® 85/1**  
Einseitig

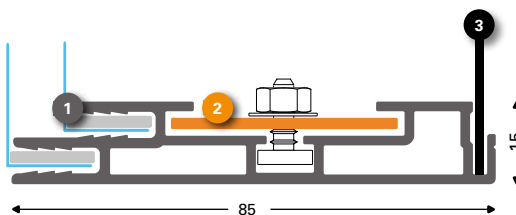
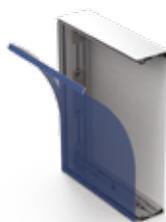

- 1 **131085 (131087\*)**  
T-Flex® 85/1 LightBox roh
  - 2 **130708**  
Eckverbinder FF
  - 3 **ACP 2 mm Verbundplatte Matt Weiß**  
Maß: H-5 mm W-5 mm
- 131089**  
Rückwandhalter 75/85/150 - 40 mm

**T-Flex® 100/1**  
Einseitig

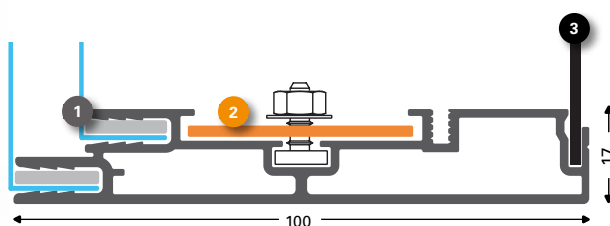

- 1 **131104(131106\*131105\*\*\*131107\*\*\*\*)**  
T-Flex® 100/1 LightBox roh
  - 2 **130708**  
Eckverbinder FF
  - 3 **ACP 2 mm Verbundplatte Matt Weiß**  
Maß: H-15 mm W-15 mm
- 131088**  
Rückwandhalter 100 - 40 mm

**T-Flex® 150/1**  
Einseitig

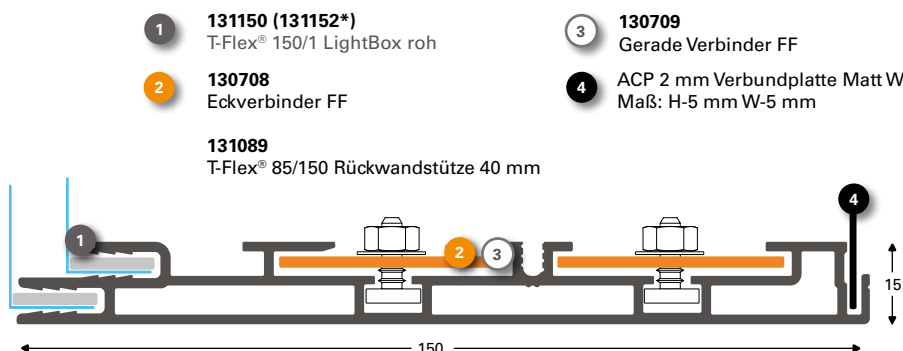

- 1 **131150 (131152\*)**  
T-Flex® 150/1 LightBox roh
  - 2 **130708**  
Eckverbinder FF
  - 3 **130709**  
Gerade Verbinder FF
  - 4 **ACP 2 mm Verbundplatte Matt Weiß.**  
Maß: H-5 mm W-5 mm
- 131089**  
T-Flex® 85/150 Rückwandstütze 40 mm

# Schaufenstersysteme



**T-Flex® 85/2 WG**  
Einseitig

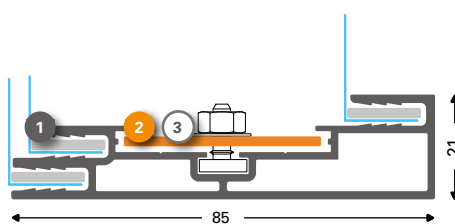
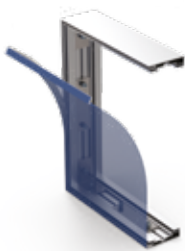

- 1 **131082 (131083\*)**  
T-Flex® 85/2 WG roh
- 2 **130708**  
Eckverbinder FF
- 3 **130709**  
Gerade Verbinder FF

**T-Flex® 140/2 WG**  
Einseitig

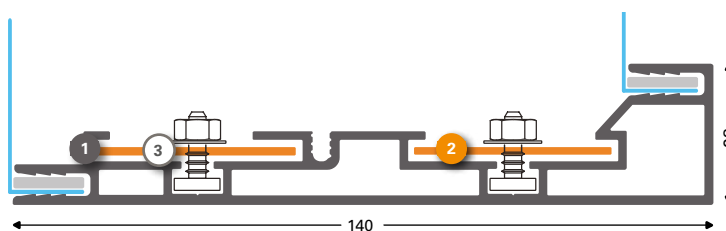
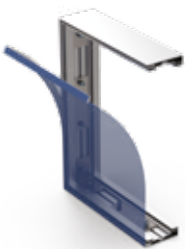

- 1 **131130 (131132\*)**  
T-Flex® 140/2 WG roh
- 2 **130708**  
Eckverbinder FF
- 3 **130709**  
Gerade Verbinder FF

\* Eloxiert Profil



# Doppelseitig beleuchtete Rahmen



**T-Flex® 60/2**  
Doppelseitig

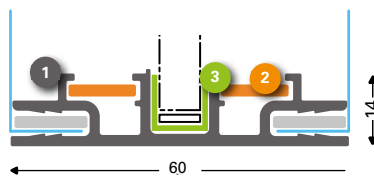
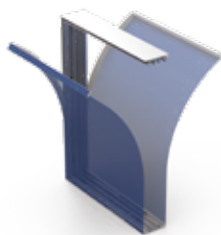

- 1 **131075 (131077\*)**  
T-Flex® 60/2 EdgeLight roh
- 2 **131078**  
Eckverbinder FF
- 3 **137422**  
LED Behälter 10x10x10x1.0 eloxiert  
- L 3000

**T-Flex® 96/2**  
Doppelseitig

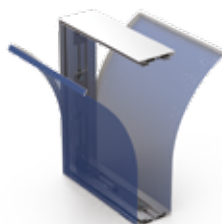

- 1 **131090 (131092\*)**  
T-Flex® 96/2 LightBox roh
- 2 **130708**  
Eckverbinder FF

- 3 **130709**  
Gerade Verbinder FF

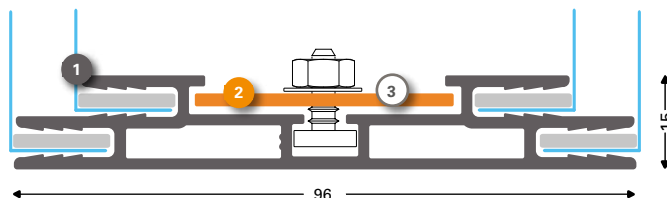

**SpeeTex® 120/2**  
Doppelseitig

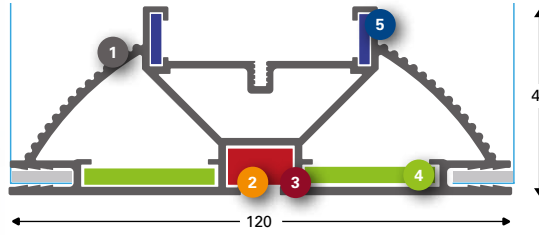

- 1 **131120 (131122\*)**  
SpeeTex® 120/2 roh
- 2 **131165**  
Spann-Eckverbinder für außen
- 3 **131124**  
SpeeTex® Eckverbinder 100 inbus
- 4 **131126**  
SpeeTex® Eckverbinder 78x78 für 120
- 5 **137154**  
Eckverbinder L Stahl Inbus

**SpeeTex® 150/2**  
Doppelseitig

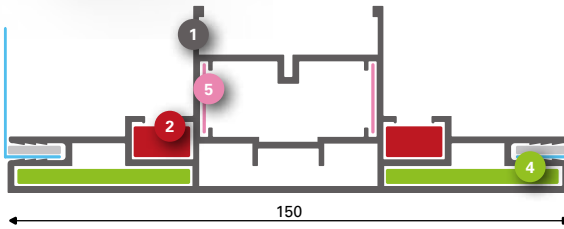
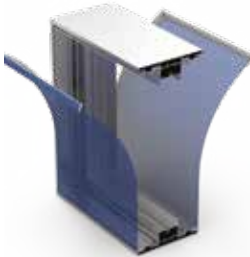

- 1 **131474 (131476\*)**  
Speetex® 150/2 geschlossen roh
- 2 **131479**  
Speetex® Eckverbinder 100 mm Innensechskant innen (125/150)

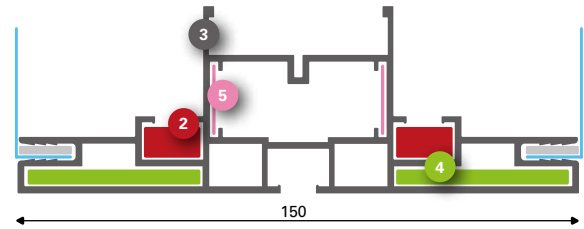

- 3 **131470 (131472\*)**  
Speetex® 150/2 offen roh
- 4 **131478**  
Eckverbinder 78 für Speetex® 150
- 5 **131164**  
Support Eckverbinder Stahl 150/160

**T-Flex® 170/2**  
Doppelseitig

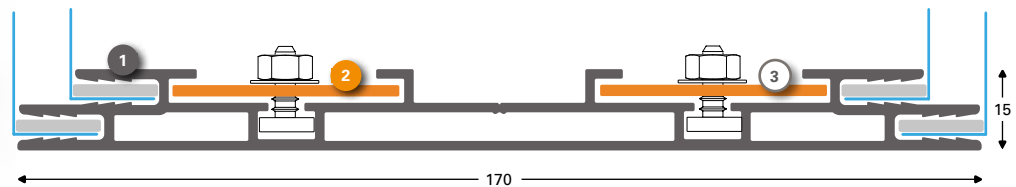

- 1 **131170 (131172\*)**  
T-Flex® 170/2 LightBox roh
- 2 **130708**  
Eckverbinder FF
- 3 **130709**  
Gerade Verbinder FF

\* Eloxiert Profil

Zubehörteile ab Seite 18 an 23



**T-Flex® Cube**  
Würfel

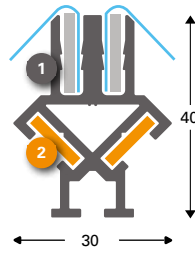

- 1 **131185 (131187\*)**  
T-Flex® Cube Rahmenprofil roh
- 2 **131180**  
T-Flex® Cube Eckverbinder

**SpeeTex® XXL Cube**  
Würfel

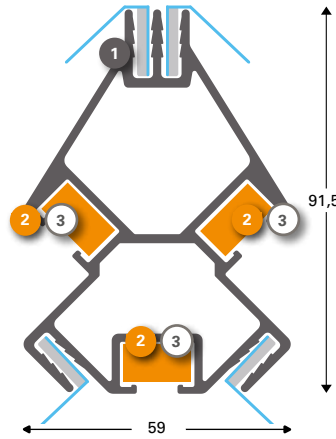

- 1 **131176 (131177\*)**  
SpeeTex® Cube XXL Rahmenprofil roh
- 2 **131175**  
SpeeTex® Cube XXL Eckstück
- 3 **131178**  
Gerade Kupplung Stahl

131175



**SpeeTex® Cube XXL Eckstück**

131179



**SpeeTex® Cube XXL  
INOX Aufhänge-Set**

131174

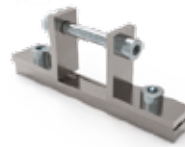

**SpeeTex® Verbindungsstück  
für die Verstärkung**

131128



**Cube XXL Standfuß M16 x 150 mm  
(justierbar)**



**T-Flex® 70 Outdoor**  
Einseitig

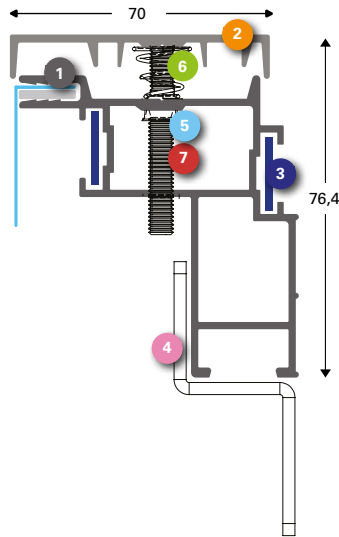

- 1 131532**  
T-Flex® 70 Outdoor Basisprofil elox
- 2 131535**  
T-Flex® 70 Outdoor Abdeckprofil elox
- 3 131538**  
T-Flex® 70 Outdoor INOX Eckverbinder
- 4 131539**  
T-Flex® 70 Outdoor INOX Haltebügel
- 5 131540**  
T-Flex® 70 Outdoor Inox Schraube ISO 7380
- 6 131541**  
T-Flex® 70 Outdoor Druckfeder
- 7 131542**  
T-Flex® 70 Outdoor INOX Blindnietmutter

**MultiFrame®**  
Doppelseitig

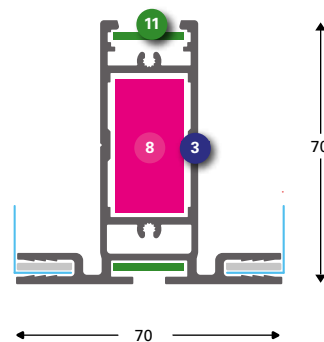
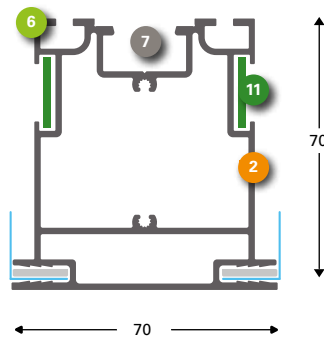
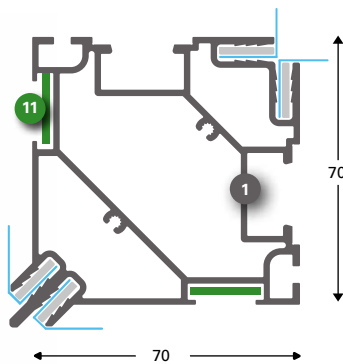

- 1 131714\* (131716\*\*)**  
MultiFrame® Winkelprofil elox
- 2 131702\* (131704\*\*)**  
MultiFrame® Seitenprofil elox
- 3 131726\* (131728\*\*)**  
MultiFrame® T-Verbindungsprofil elox
- 4 131708 (131710\*)**  
Endstück Seitenprofil [131702] elox
- 5 131720 (131722\*)**  
Endstück Winkelprofil [131714] elox
- 6 131018**  
Verstärkungsprofil S elox
- 7 133613**  
Verstärkungsprofil L elox
- 8 139758**  
T-Verbinder 40 elox (133613)
- 9 139738**  
Bohrschablone T-Verbinder 139758
- 10 131022**  
Schnellverbinder gerade [131018]
- 11 131543**  
INOX Verbinder recht [131724/26 ,131532]

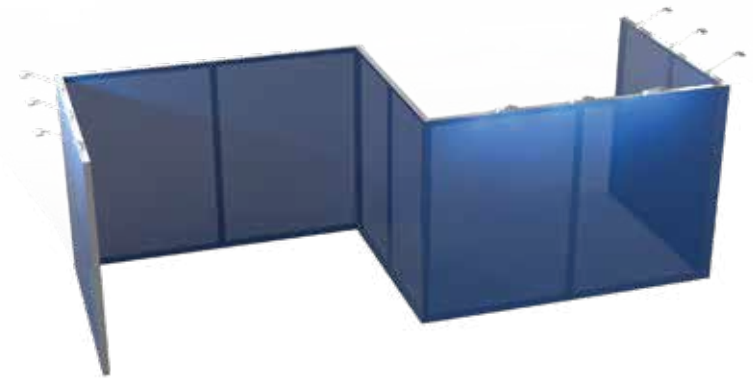
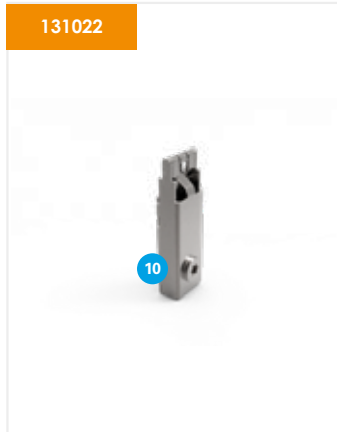
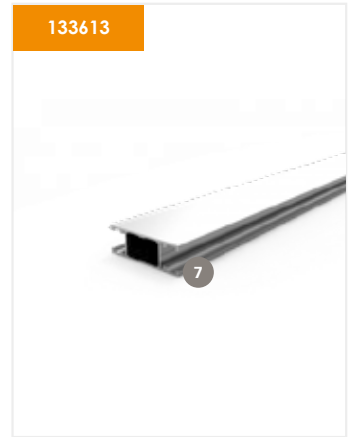
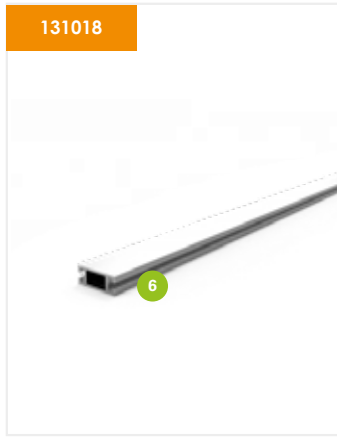
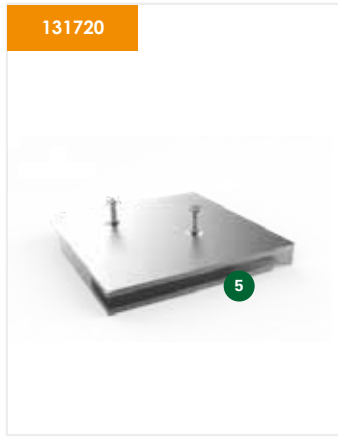
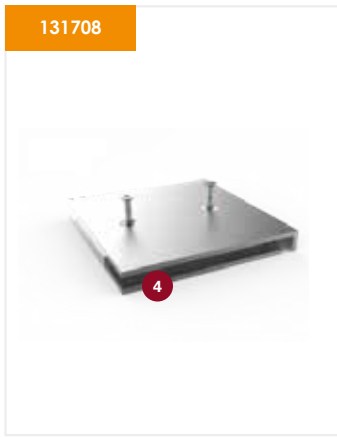

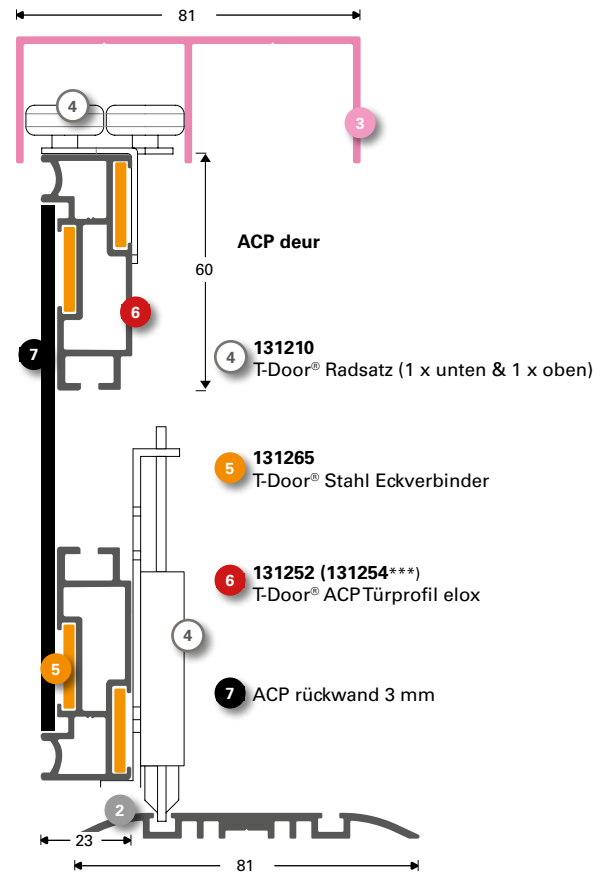
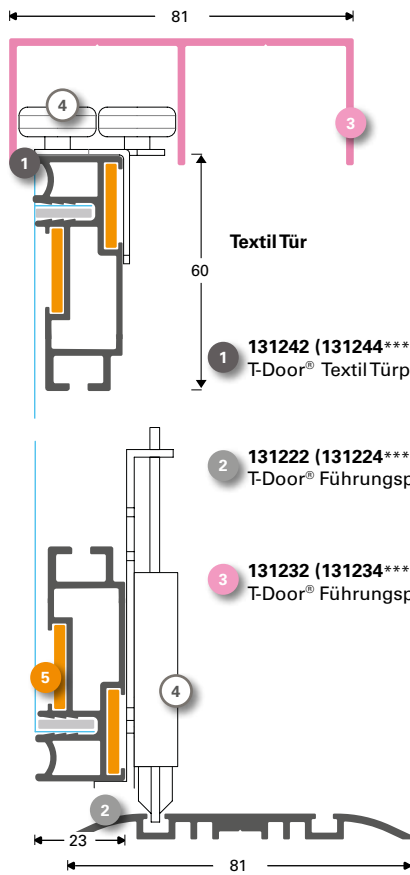

\* eloxiert Profil \*\* RAL 9003 Profil \*\*\* Schwarz eloxiert Profil

## Schiebetür-System T-Door® für Textil & Aluminium-Verbundplatte



# Keder® Spezifikationen

<b>Sign System:</b>	Kederprofile für Messebau & Werbetechnik
<b>Eigenschaften:</b>	Profile und Zubehör für Textil (PVC) Spannwände
<b>Medium:</b>	Textil und/oder PVC Spanntücher
<b>Anwendung:</b>	Für den Innen - & Außenbereich
<b>Ausführung:</b>	Einseitig & doppelseitig
<b>Profil:</b>	6100 mm, EN AW6060 T6, erhältlich in roh oder eloxiert
<b>Zubehör:</b>	Endkappen & Montagematerial

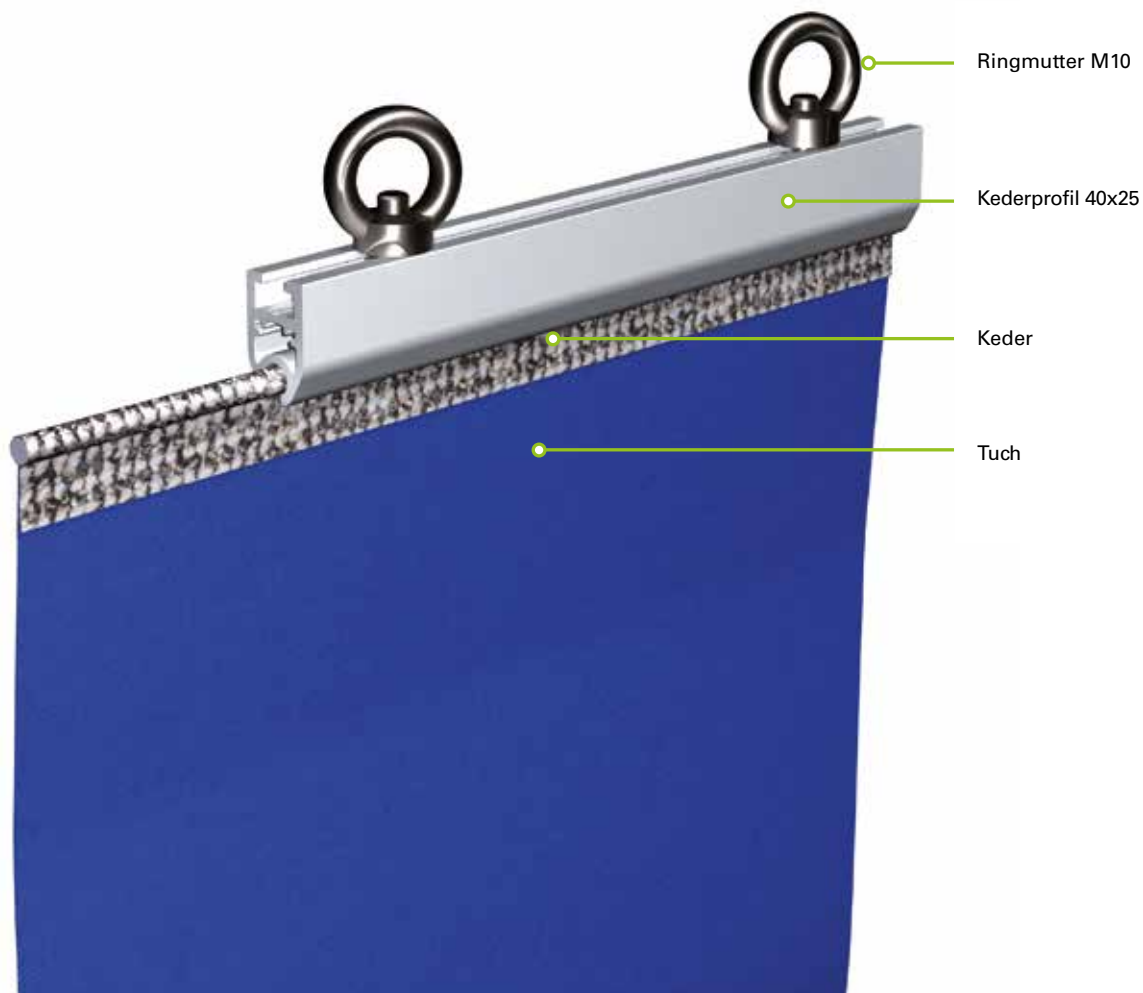
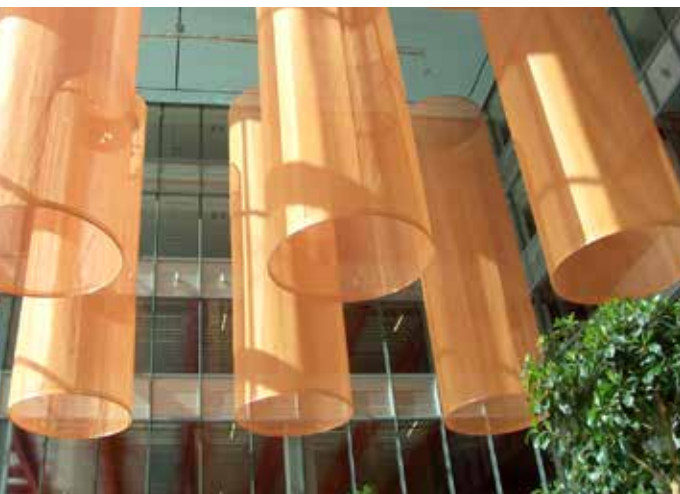



**Keder® 30/2**  
Doppelseitig

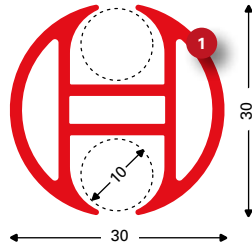

- 1 138660 (138662\*)**  
Keder profil 30/2 roh
- 138663**  
Kunststoff Endstück Keder 30/2 Schwarz
- 2 138654**  
Gerade Kupplung Keder 30-44/2 Stahl
- 3 138653**  
Scharnierverbinder Stahl für Kederprofil 30-44/2

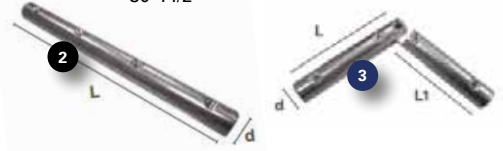

**Keder® 44/2**  
Doppelseitig

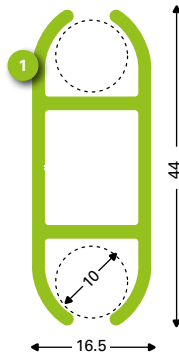

- 1 138639 (138642\*)**  
Kederprofil 44/2 roh
- 138652**  
Kunststoff Endstück 138639/42 grau
- 2 138655**  
Aufhänger M5 mit Haken 30-44/2



**Keder® 40/25**  
Einseitig

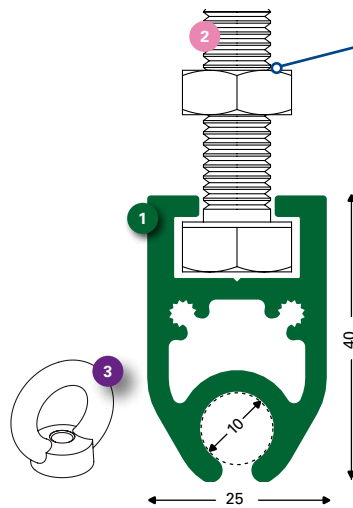
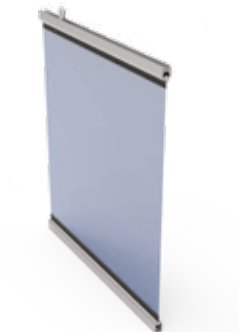

**M10**  
Maximale Schlüssel Breite 17mm /  
Ringmutter M10 (138640)

- 1 138645 (138647\*)**  
Kederprofil 40x25 roh/eloxiert
- 138648\***  
Endstück 138647 elox
- 2 138641**  
Inox A2 Bolzen M10 x 20 DIN 933
- 3 138640**  
Aufhängeöse M10 INOX
- 138656**  
Gerade Kupplung Keder 40/25 Stahl

**Keder® 39/2**  
Einseitig

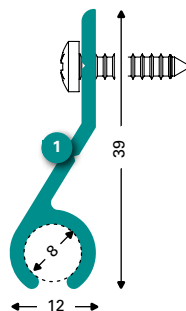

- 1 134110**  
Kederprofil 39x12 roh

# Teile und Zubehör Textilspannrahmen

BESTELLEN  
SIE JETZT EINEN  
MUSTERBOX!

Eckige und gerade Verbinder



Eckverbinder Stahl 17, 35 & 60



Eckverbinder M Stahl Inbus



Eckverbinder L Stahl Inbus



Eckverbinder 60x60x5.0 11 mm roh

131124



SpeeTex® Eckverbinder 100 inbus

130708



Eckverbinder FF

131165



Spann-eckverbinder für außen

131265



T-Door® Stahl Eckverbinder

131538



T-Flex® 70 Outdoor I  
NOX Eckverbinder

131126



SpeeTex® Eckverbinder 78x78

131166



SpeeTex® 160 Eckverbinder 78x78

131025



Only in combination with 137154

T-Flex® Kunststoff Eckstück Grau

131026



Only in combination with 137154

T-Flex® Kunststoff Eckstück  
Schwarz

131168



Gerade Support-Verbinder Stahl  
150/160

131478

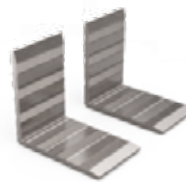

Eckverbinder 78 für Speetex® 150

Rückwandhalter

131059



Rückwandhalter 50/55 - 40 mm

131089



Rückwandhalter 75/85/150 - 40 mm

131088



Rückwandhalter 100 - 40 mm

# Teile und Zubehör **Textilspannrahmen**



**T-Flex® 17** Ecklösung 45x45 mm elox



**T-Flex® 23** Ecklösung 45x45 mm elox



**T-Flex® 46** Ecklösung 45x45 mm elox



**Gerade Verbinder 100 mm** elox

Vormontierte Ecken

130709

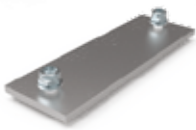

**Gerade Verbinder FF**

131178



**Gerade Kupplung Stahl**

131169



**Einstellbarer Click Eckverbinder**

131174

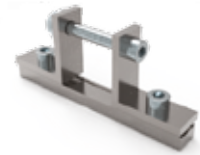

**SpeeTex®** Verbindungsstück für die Verstärkung

Gerade Verbinder

131030



**T-Flex®** Scharnier elox

131031



**T-Flex®** Scharnier Schwarz elox

131479



**Speetex®** Eckverbinder 100 mm Innensechskant innen

131164



**Support** Eckverbinder Stahl 150/160

131708



**Endstück Seitenprofil** [131702] elox

131720



**Endstück Winkelprofil** [131714] elox

133613



**Verstärkungsprofil L** elox

139758



**T-Verbinder 40** elox (133613)

139738



**Bohrschablone T-Verbinder** 139758

131543



**INOX** Verbinder recht [131724/26, 131532]



# Teile und Zubehör **Textilspannrahmen**

Verstärkungsprofile

131018



Verstärkungsprofil S elox

131022



Schnellverbinder gerade  
[131018]

131023



Schnellverbinder 45 Grad  
L+R[131018]

131028



45 grad Verstärkung 750 mm elox

131097



Stützanker 25 mm mit Löcher

131098



Stützanker 25 mm mit Locher  
(+2 Bolzen/Mutter)

131099



Stützanker 25 mm ohne Löcher

131174



SpeeTex® Verbindungsstück für  
die Verstärkung

130889



Distanz-Versteifungsprofil 40x36  
RAL 9016

131145



Gewindeplatte für Fuß  
[131085/131090]

Standfüße

131338



Fuß Wand-Basic Aluminium  
elox L: 223 mm

131118



Fuß B Stahl 400x60 RAL 9006

131340



Fuß S-Basic Aluminium elox  
L: 400 mm

131339



Fuß M-Basic Aluminium elox  
L: 600 mm

131037

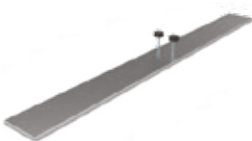

Fuß L Aluminium elox

131034



Fuß G Aluminium elox

131139















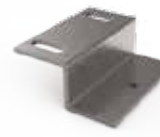







SpeeTex® Fuß 500 120/150/160  
elox

131140

















SpeeTex® Fuß (Wand) 330  
120/150/160 elox

# Stahlseile inklusive Zubehör für die einfache und schnelle Montage von u.a. Textilspannrahmen

<p>131079</p>  <p>Verschiebbare Montagehalterung T-17</p>	<p>131319</p>  <p>Wand Aufhänger für T-Flex® 23/30 basic elox</p>	<p>131539</p>  <p>T-Flex® 70 Outdoor INOX Haltebügel</p>	<p>131113</p>  <p>Wand Aufhänger für T-Flex® 46 basic elox</p>
<p>131111</p>  <p>Wand Aufhänger für T-Flex® 46 elox</p>	<p>131173</p>  <p>Aufhängeöse M8 INOX Ring +Klotz</p>	<p>130655</p>  <p>Aufhängesatz Stahlseil mit Haken 3 m T2 INOX</p>	<p>130298</p>  <p>Aufhängehaken roh (130297)</p>
<p>138730</p>  <p>ECO Drahtseilhalter (34,5 x 10 mm Seitenausgang)</p>	<p>138734</p>  <p>Zyl. Drahtseilhalter (28,5x12 mm Seitenausgang)</p>	<p>138732</p>  <p>Konische Drahtseilhalter (40x18 mm Seitenausgang)</p>	<p>138751</p>  <p>Doppelgripper Schwarz 3.0 mm</p>
<p>138752</p>  <p>Doppelgripper Silber (1,5 mm)</p>	<p>138753</p>  <p>Doppelgripper Schwarz (1,5 mm)</p>	<p>138750</p>  <p>Doppelgripper 3.0 mm Silber</p>	<p>138762</p>  <p>Drahtseilhalter mit Auge für Deckenmontage</p>
<p>138761</p>  <p>Drahtseilhalter für Deckenmontage</p>	<p>138706</p>  <p>Stahlkabel mit Kugel 4,5 x 1,5 mm L 1500 mm</p>	<p>138646</p>  <p>Aufhängeöse M6 INOX</p>	<p>138649</p>  <p>Aufhängeöse M8 INOX</p>

# Teile und Zubehör Textilspanrahmen

Magnete	139345		Heavy Duty Magnet 32 x 7,0 mm
	138710		Power Magnet 25 x 8,5 mm
	138760		Drahtseilhalter mit Magnet 32 mm
	131041		Sechskantdreher 2,5 mm ISO 2936
Werkzeug	131043		Sechskantdreher 3,0 mm ISO 2936
	131024		Torx-Schlüssel für Schnellverbinder [131022/023/027]
	131029		T-Flex® Inbusschlüssel (M4) 2,0 mm
	131017		Gummiroller 131021
Keder	131464		Flach Keder 12x3 PVC Weiß (roll = 200 Lfm)
	131466		Flach Keder 14x3 PVC Weiß (roll = 200 Lfm)
	131460		Flach Keder 12x3 PVC klar (roll = 200 Lfm)
	131462		Flach Keder 14x3 PVC klar (roll = 200 Lfm)
131020		Silikonkeder (annähen) 14 x 3 mm	
131021		Einrollkeder grau (200 m)	



IMMER  
AB LAGER  
LIEFERBAR!

## Standbau Systeme

1 **131035\*\***  
T-Flex® Verbindungsprofil elox

2 **131018\***  
Verstärkungsprofil S elox

3 **131022**  
Schnellverbinder gerade [131018]

4 **131023**  
Schnellverbinder 45 Grad L+R [131018]

**131024**  
Torx-Schlüssel für Schnellverbinder [131022/023/027]



\* RAL 7021 / RAL 7021 / RAL 7021 \*\* RAL 7021 structuur / RAL 7021 Structure / RAL 7021 Struktur

## Magnetischer Regalhalter

1 **139342**  
Magnet plankdrager vom-1

2 **139345**  
Heavy Duty magnet 32 x 7,0 mm

**139344**  
Eindkap magnet plankdrager vom-1

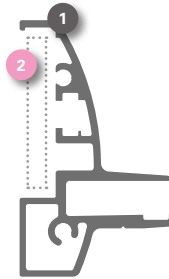

## Musterkartons

1 **132251**  
Musterbox T-Flex® Textilspannrahmen

2 **132252**  
Musterbox T-Flex® LED Rahmen + Muster ACP 2 mm

3 **132253**  
Musterbox SpeeTex® Textilspannrahmen



## Rahmenlose Textilspannrahmen von Comhan | Überraschend vielseitig, auffallend flexibel!

Die Anwendungsmöglichkeiten der T-Flex-Textilspannrahmen von Comhan sind nahezu unbegrenzt. Dieser intelligente Indoor-Werbeträger ist u. a. ideal für:

- Schaufensterwerbung
- Flughäfen
- Hotel- und Gaststättengewerbe
- Ausstellungsräume
- Messen
- Firmengebäude
- Veranstaltungen
- Schiebetüren

Über Werbetechniker & Digitale Druckbetriebe, wird unsere T-Flex® Serie, an die Welt der visuellen Kommunikationsindustrie geliefert. Für Großverbraucher gelten spezielle Konditionen.



Für weitere Informationen oder eine kostenlose Produktschulung rufen Sie uns an unter Tel.: 02331 625 1900 oder schreiben eine E-Mail an die [comhan@comhan.de](mailto:comhan@comhan.de)

### T-Flex® Textilspannrahmen: Eine Innovation im Bereich der visuellen Kommunikation!

Comhan bringt mit dem T-Flex-Textilspannrahmen einen vielseitigen Aluminiumrahmen für das Aufspannen bedruckter Textilien und Banner auf den Markt. Schnell, einfach und flexibel. Dieser für Innenanwendungen gedachte Rahmen, ist in einer ein- & doppelseitigen Variante erhältlich. Die Serie umfasst mehr als 30 Modelle und eignet sich hervorragend für Situationen, in denen der Stoff regelmäßig gewechselt werden muss.



Würfelsysteme



Gebogene Profile



T-Door® Schiebetürsystem

Bestellen Sie unseren kostenlosen Sign-Katalog auf unserer Website.



**COMHANHOLLAND**  
ALUMINIUM

NL • Amsterdamseweg 27 • 1422 AC Uithoorn • Holland  
T +31 (0)297 513 636 • E [comhan@comhan.com](mailto:comhan@comhan.com)

DE • Neue Straße 23 • D 58135 Hagen • Deutschland  
T +49 (0)2331 625 1900 • F +49 (0)2331 625 1927 • E [comhan@comhan.de](mailto:comhan@comhan.de)